

# **BERNARDO**®

www.bernardo.at

05 | 2025

## **PLANING MACHINES**



PT 200  
PT 200 S

PT 200 ED  
PT 200 EDS  
PT 250  
PT 250 S  
PT 305  
PT 305 S  
PT 260  
PT 260 S  
ADH 250 P  
ADM 260

ADM 260 S  
AD 260  
AD 260 S  
PT 305 D  
PT 305 DS  
FS 310 P  
FS 310 PS  
PT 310  
PT 310 S  
ADM 300 / 300 V

AD 310  
AD 310 S  
FS 410 P  
FS 410 PS  
PT 410  
PT 410 S  
AD 410  
AD 410 S  
SP 150 PN  
SP 150 PS

SP 200 PN  
SP 200 PS  
TH 330  
TH 330 S  
DH 310  
DH 310 S  
DH 410  
TP 410  
DH 410 S  
TP 630 D

# Surface planer and thicknessers

The PT 200 surface planer and thicknesser features a small and compact construction to allow for easy transport and use on different sites.

## PT 200

- Cutterblock cover in accordance with CE-standards guarantees high safety
- On/Off switch in accordance with IP 54 features undervoltage release
- Ideal for craftsmen and home users
- Quick and easy setting of chip removal
- Precise aluminium planing tables to achieve high accuracy
- Combined dust hood can be used for planing or thicknessing
- Solid planing fence tilts 90° to 45°
- Precisely bedded 2-knife cutterblock with HSS cutter knives
- Powerful drive motor for optimal planing results
- Attractive price-benefit ratio



Combined dust hood can be used for surface planing or thicknessing.



Aluminium planing fence can be used from 90° to 45°.

**BERNARDO**  
www.bernardo.at  
**HOBBY**

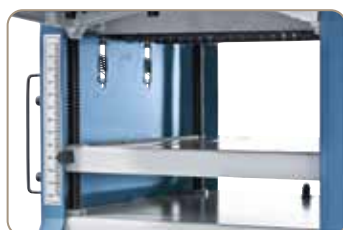

Thicknessing table on four guides, height adjustable on clearly designed scale.



On-Off switch in accordance to IP 54 and separate emergency stop button according to CE standards.

### Optional accessories:

	Art. no.	excl. VAT
Set of planer knives in HSS-quality (2 pcs.)	15-1067	
Planer knife adjustment HML	08-1500	
Suction canister BDC 1200	12-1996	

### Technical data

#### PT 200

#### Planer

Planing width	205 mm
Table length	740 mm
Shaft rotation speed	8500 rpm
Cutter knives	2 pcs.
Planer shaft diameter	50 mm
Planer fence	540 x 100 mm
Fence tiltable	90° to 45°
Max. cutting depth	2 mm

#### Thicknesser

Table length	255 mm
Working width	200 mm
Working thickness, min./max.	8 - 120 mm
Max. cutting depth	2 mm
Feed speed	7 m/min

Dust extraction outlet	60 mm
Motor power output S <sub>1</sub> 100%	1,25 kW (1,7 HP)
Motor power input S <sub>6</sub> 40%	1,75 kW (2,3 HP)
Voltage	230 V
Machine dimension (L x W x H)	790 x 460 x 480 mm
Weight approx.	27 kg
Art. no.	08-1005

### Standard accessories:

- Cutter knives in HSS-quality
- Dust hood
- Knife gauge
- Push handle

**Best  
Price**

# Surface planer and thicknesser

## PT 200 S

The PT 200 S surface planer and thicknesser features a small and compact construction to allow for easy transport and use on different sites. Another advantage is the spiral cutter head for reduced noise level and optimal planing results.

- Reduction of noise level (approx. 50%) due to the standard spiral cutter head and up to 20 times the cutting edge life (results from four-way carbide inserts)
- Advantage of the carbide inserts: If damaged, individual knives can be exchanged or turned
- The carbide blades ensure tear-free planing results and optimal surfaces with any type of wood
- Cutterblock cover in accordance with CE-standards guarantees high safety
- Ideal for craftsmen and home users
- Quick and easy setting of chip removal
- Precise aluminium planing tables to achieve high accuracy
- Combined dust hood can be used for planing or thickening
- Powerful drive motor for optimal planing results

Spiral cutter head as standard



The dynamically balanced spiral cutter head ensures smooth, vibration-free planing, guarantees best results.



Thicknessing table on four guides, height adjustable on clearly designed scale.

### Standard accessories:

- Spiral cutter head with 18 pcs. TCT-blades
- Replacement TCT-blades (5 pcs.)
- Dust hood
- Push handle

Technical data	PT 200 S
<b>Planer</b>	
Planing width	205 mm
Table length	740 mm
Shaft rotation speed	8000 rpm
TCT-blades	18 pcs.
Planer shaft diameter	50 mm
Planer fence	540 x 100 mm
Fence tiltable	90° to 45°
Max. cutting depth	2 mm
<b>Thicknesser</b>	
Table length	250 mm
Working width	200 mm
Working thickness, min./max.	5 - 120 mm
Max. cutting depth	2 mm
Feed speed	6,5 m/min
<b>Dust extraction outlet</b>	
Dust extraction outlet	60 mm
Motor power output S <sub>1</sub> 100%	1,5 kW (2,0 HP)
Motor power input S <sub>6</sub> 40%	2,1 kW (2,8 HP)
Voltage	230 V
Machine dimension (L x W x H)	790 x 460 x 480 mm
Weight approx.	27 kg
Art. no.	08-10050



**BERNARDO**  
HOBBY

NEW

Best Price



On-Off switch in according to IP 54 and separate emergency stop button according to CE standards.

### Optional accessories:

- TCT-blades for spiral cutter (10 pcs.)
- Spare screws of spiral cutter blade (10 pcs.)
- Torque wrench 6 Nm
- Suction canister BDC 1200

Art. no.	excl. VAT
15-1078	
15-1079	
15-1080	
12-1996	

# Surface planer and thicknesser

## PT 200 ED

The PT 200 ED planer and thicknesser stands out because of its integrated dust extractor and its large thickening height (210mm). This compact model is solidly constructed, making this machine ideal for amateurs.

- Solid machine structure enables easy transportation, ideal for use on construction sites
- Quick and easy adjustment of chip removal
- Dust extractor and waste bag as standard equipment
- Stable planer fence, tiltable from 90° to 45°
- Precisely manufactured, aluminium planing tables for accurate results
- Power switch according to IP 54 with undervoltage release
- Precisely mounted 2-knife cutterblock incl. cutter knives in HSS-quality
- Cutterblock cover according to CE-standards ensure safety
- Powerful motor guarantees best result
- Ideal for craftsmen and amateurs
- Serially equipped with dust hood when thickening



The planer fence can easily be adjusted from the back of the machine. The desired angle can be read on the scale.



The table is guided on four threads to ensure precise planing of boards, planks etc.



Cutterblock cover according to CE standards.

**Working thickness 210 mm and integrated dust extraction**



### Optional accessories:

	Art. no.	excl. VAT
Set of planer knives in HSS quality (2 pcs.)	15-1067	
Planer knife adjustment HML	08-1500	
Filter bag	97-79439	

### Technical data

### PT 200 ED

#### Planer

Planing width	205 mm
Table length	740 mm
Shaft rotation speed	8500 rpm
Cutter knives	2 pcs.
Planer shaft diameter	50 mm
Planer fence	540 x 105 mm
Fence tiltable	90° to 45°
Max. cutting depth	2 mm

#### Thicknesser

Table length	285 mm
Working width	200 mm
Working thickness, min./max.	5 - 210 mm
Max. cutting depth	2 mm
Feed speed	7 m/min

Dust extraction outlet	60 mm
Motor power output S <sub>1</sub> 100%	1,5 kW (2,0 HP)
Motor power input S <sub>6</sub> 40%	2,1 kW (2,8 HP)
Voltage	230 V
Machine dimension (L x W x H)	790 x 480 x 550 mm
Weight approx.	28 kg
Art. no.	08-1006

### Standard accessories:

- Cutter knives in HSS-quality
- Dust extractor
- Knife gauge
- Dust hood
- Waste bag
- Push handle



Serially equipped with integrated dust extractor and waste bag.

# Surface planer and thicknesser

# PT 200 EDS

The PT 200 EDS planer and thicknesser stands out because of its integrated dust extractor and its large thickening height (210mm). Another advantage is the spiral cutter head for reduced noise level and optimal planing results.

- Reduction of noise level (approx. 50%) due to the standard spiral cutter head and up to 20 times the cutting edge life (results from four-way carbide inserts)
- Advantage of the carbide inserts: If damaged, individual knives can be exchanged or turned
- The carbide blades ensure tear-free planing results and optimal surfaces with any type of wood
- Solid machine structure enables easy transportation, ideal for use on construction sites
- Dust extractor and waste bag as standard equipment
- Stable planer fence, tiltable from 90° to 45°
- Precisely manufactured, aluminium planing tables for accurate results
- Powerful motor guarantees best result
- Ideal for craftsmen and amateurs
- Serially equipped with dust hood when thickening



The table is designed with slots on both sides and a spiral cutter head to minimize the noise level.



The dust hood can be used for both planing and thickening.

Spiral cutter head as standard

NEW



Working thickness 210 mm and integrated dust extraction

### Standard accessories:

- Spiral cutter head with 24 pcs. TCT-blades
- Replacement TCT-blades (5 pcs.)
- Integrated dust extractor
- Dust hood
- Waste bag
- Push handle

Technical data	PT 200 EDS
<b>Planer</b>	
Planing width	205 mm
Table length	740 mm
Shaft rotation speed	8500 rpm
TCT-blades	18 pcs.
Planer shaft diameter	50 mm
Planer fence	540 x 105 mm
Fence tiltable	90° to 45°
Max. cutting depth	2 mm
<b>Thicknesser</b>	
Table length	285 mm
Working width	200 mm
Working thickness, min./max.	5 - 210 mm
Max. cutting depth	2 mm
Feed speed	7 m/min
Dust extraction outlet	60 mm
Motor power output S <sub>1</sub> 100%	1,5 kW (2,0 HP)
Motor power input S <sub>6</sub> 40%	2,1 kW (2,8 HP)
Voltage	230 V
Machine dimension (L x W x H)	790 x 480 x 550 mm
Weight approx.	28 kg
Art. no.	08-10060



Serially equipped with integrated dust extractor and waste bag.

### Optional accessories:

- TCT-blades for spiral cutter (10 pcs.)
- Spare screws of spiral cutter blade (10 pcs.)
- Torque wrench 6 Nm
- Filter bag

Art. no.	excl. VAT
15-1078	
15-1079	
15-1080	
97-79439	

# Surface planer and thicknesser

The PT 250 surface planer and thicknesser features a small and compact construction to allow for easy transport and use on different sites. This model comes complete with a machine base.

## PT 250

- Cutterblock cover in accordance with CE-standards guarantees high safety
- On/Off switch in accordance with IP 54 features undervoltage release
- Ideal for craftsmen and home users
- Quick and easy setting of chip removal
- Precise aluminium planing tables to achieve high accuracy
- Combined dust hood can be used for planing or thicknessing
- Solid planing fence tilts 90° to 45°
- Precisely bedded 2-knife cutterblock with HSS cutter knives
- Powerful drive motor for optimal planing results
- Solid machine structure enables easy transportation, ideal for use on construction sites



Thicknessing table on four guides, height adjustable on clearly designed scale.



The planing tables are designed with slots to keep noise levels to a minimum.



Inclusive stand

**BERNARDO**  
www.bernardo.at  
**HOBBY**

### Optional accessories:

	Art. no.	excl. VAT
Set of planer knives in HSS-quality (2 pcs.)	15-1071	
Planer knife adjustment HML	08-1500	
Suction canister BDC 1200	12-1996	

### Technical data

### PT 250

#### Planer

Planing width	255 mm
Table length	925 mm
Shaft rotation speed	8500 rpm
Cutter knives	2 pcs.
Planer shaft diameter	50 mm
Planer fence	620 x 125 mm
Fence tiltable	90° to 45°
Max. cutting depth	2 mm

#### Thicknesser

Table length	380 mm
Working width	250 mm
Working thickness, min./max.	5 - 120 mm
Max. cutting depth	2 mm
Feed speed	7 m/min

Dust extraction outlet	75 mm
Motor power output S <sub>1</sub> 100%	1,5 kW (2,0 HP)
Motor power input S <sub>6</sub> 40%	2,1 kW (2,8 HP)
Voltage	230 V
Machine dimension (L x W x H)	970 x 460 x 990 mm
Weight approx.	29 kg
Art. no.	08-1007

Aluminium planing fence can be used from 90° to 45°.

### Standard accessories:

- Cutter knives in HSS-quality
- Dust hood
- Knife gauge
- Push handle
- Stand



# Surface planer and thicknesser

# PT 250 S

The PT 250 S surface planer and thicknesser features a small and compact construction to allow for easy transport and use on different sites. Another advantage is the spiral cutter head for reduced noise level and optimal planing results.

- Reduction of noise level (approx. 50%) due to the standard spiral cutter head and up to 20 times the cutting edge life (results from four-way carbide inserts)
- Advantage of the carbide inserts: If damaged, individual knives can be exchanged or turned
- The carbide blades ensure tear-free planing results and optimal surfaces with any type of wood
- Cutterblock cover in accordance with CE-standards guarantees high safety
- Quick and easy setting of chip removal
- Precise aluminium planing tables to achieve high accuracy
- Combined dust hood can be used for planing or thicknessing
- Solid planing fence tilts 90° to 45°
- Powerful drive motor for optimal planing results

**NEW**



**Inclusive stand**

The dynamically balanced spiral cutter head ensures smooth, vibration-free planing, guarantees best results.



The planer fence can easily be adjusted from the back of the machine. The desired angle can be read on the scale.

**BERNARDO**  
www.bernardo.at  
**HOBBY**



**Spiral cutter head as standard**

## Technical data PT 250 S

Planer	
Planing width	255 mm
Table length	925 mm
Shaft rotation speed	8500 rpm
TCT-blades	24 pcs.
Planer shaft diameter	50 mm
Planer fence	640 x 125 mm
Fence tiltable	90° to 45°
Max. cutting depth	2 mm
Thicknesser	
Table length	380 mm
Working width	250 mm
Working thickness, min./max.	5 - 120 mm
Max. cutting depth	2 mm
Feed speed	7 m/min
Dust extraction outlet	75 mm
Motor power output S <sub>1</sub> 100%	1,5 kW (2,0 HP)
Motor power input S <sub>6</sub> 40%	2,1 kW (2,8 HP)
Voltage	230 V
Machine dimension (L x W x H)	970 x 460 x 990 mm
Weight approx.	32 kg
Art. no.	08-10070

### Standard accessories:

- Spiral cutter head with 24 pcs. TCT-blades
- Replacement TCT-blades (5 pcs.)
- Dust hood
- Push handle
- Stand

### Optional accessories:

- TCT-blades for spiral cutter (10 pcs.)
- Spare screws of spiral cutter blade (10 pcs.)
- Torque wrench 6 Nm
- Suction canister BDC 1200

Art. no.	excl. VAT
15-1078	
15-1079	
15-1080	
12-1996	

# Surface planer and thicknesser

The PT 305 compact surface planer and thicknesser features a working thickness of up to 150 mm, making it the ideal model for planing of boards, planks and beams. This compact model is solidly constructed, making this machine ideal for amateurs.

## PT 305

- The table is designed with slots on both sides to minimize the noise level
- Quick and easy adjustment of chip removal
- Stable planer fence, tiltable from 90° to 45°
- Precisely manufactured, aluminium planing tables for accurate results
- Precisely mounted 2-knife cutterblock incl. cutter knives in HSS-quality
- Cutterblock cover according to CE-standards ensure safety
- Powerful motor guarantees best result
- Combined dust hood can be used for planing or thicknessing
- Ideal for craftsmen and amateurs
- Thicknessing table is guided on four threads to ensure accurate planing of boards, planks, etc.



Combined dust hood can be used for surface planing or thicknessing.



Quick and easy adjustment of chip removal (up to 2 mm).



Thicknessing table is guided on four threads. The height can be read on the scale.

### Standard accessories:

- Cutter knives in HSS-quality
- Knife gauge
- Dust hood
- Push handle

**BERNARDO**  
www.bernardo.at

**HOBBY**

### Technical data

### PT 305

#### Planer

Planing width	305 mm
Table length	1075 mm
Shaft rotation speed	9500 rpm
Cutter knives	2 pcs.
Planer shaft diameter	51 mm
Planer fence	640 x 125 mm
Fence tiltable	90° to 45°
Max. cutting depth	2 mm

#### Thicknesser

Table length	500 mm
Working width	300 mm
Working thickness, min./max.	5 - 150 mm
Max. cutting depth	1 mm
Feed speed	7 m/min

Dust extraction outlet	100 mm
Motor power output S <sub>1</sub> 100%	1,8 kW (2,4 HP)
Motor power input S <sub>6</sub> 40%	2,5 kW (3,4 HP)
Voltage	230 V
Machine dimension (L x W x H)	1125 x 560 x 575 mm
Weight approx.	46 kg
Art. no.	08-1009



**BEST-PRICE!**



Aluminium planing fence can be used from 90° to 45°.

### Optional accessories:

Set of planer knives in HSS-quality (2 pcs.)	Art. no.	excl. VAT
Planer knife adjustment HML	15-1074	
Suction canister BDC 1200	08-1500	
	12-1996	

# Surface planer and thicknesser

# PT 305 S

The PT 305 S compact surface planer and thicknesser features a working thickness of up to 150 mm, making it the ideal model for planing of boards, planks and beams. Another advantage is the spiral cutter head for reduced noise level and optimal planing results.

- Reduction of noise level (approx. 50%) due to the standard spiral cutter head and up to 20 times the cutting edge life (results from four-way carbide inserts)
- Advantage of the carbide inserts: If damaged, individual knives can be exchanged or turned
- The carbide blades ensure tear-free planing results and optimal surfaces with any type of wood
- The table is designed with slots on both sides to minimize the noise level
- Stable planer fence, tiltable from 90° to 45°
- Cutterblock cover according to CE-standards ensure safety
- Powerful motor guarantees best result
- Combined dust hood can be used for planing or thicknessing
- Thicknessing table is guided on four threads to ensure accurate planing of boards, planks, etc.



The planing unit consists of a dynamically balanced spiral cutter head, in- and outfeed roller and massive anti-kickback devices.

**Spiral cutter head as standard**



On-Off switch in according to IP 54 and separate emergency stop button according to CE standards.

**BERNARDO**  
www.bernardo.at  
**HOBBY**

**NEW**

## Standard accessories:

- Spiral cutter head with 28 pcs. TCT-blades
- Replacement TCT-blades (5 pcs.)
- Dust hood
- Push handle

Technical data	PT 305 S
<b>Planer</b>	
Planing width	300 mm
Table length	1075 mm
Shaft rotation speed	9500 rpm
TCT-blades	28 pcs.
Planer shaft diameter	50 mm
Planer fence	640 x 125 mm
Fence tiltable	90° to 45°
Max. cutting depth	2 mm
<b>Thicknesser</b>	
Table length	500 mm
Working width	305 mm
Working thickness, min./max.	5 - 150 mm
Max. cutting depth	2 mm
Feed speed	7,5 m/min
<b>Dust extraction outlet</b>	
Dust extraction outlet	100 mm
Motor power output S <sub>1</sub> 100%	1,8 kW (2,4 HP)
Motor power input S <sub>6</sub> 40%	2,5 kW (3,4 HP)
Voltage	230 V
Machine dimension (L x W x H)	1125 x 560 x 575 mm
Weight approx.	47 kg
Art. no.	08-10090



Aluminium planing fence can be used from 90° to 45°.

## Optional accessories:

- TCT-blades for spiral cutter (10 pcs.)
- Spare screws of spiral cutter blade (10 pcs.)
- Torque wrench 6 Nm
- Suction canister BDC 1200

Art. no.	excl. VAT
15-1078	
15-1079	
15-1080	
12-1996	

# Surface planer and thicknesser

# PT 260

- Both planing tables feature fine adjustment and are designed with slots to keep noise levels down
- Thickening table is guided on four threads to ensure accurate planing of boards, planks, etc.
- Integrated dust extractor guarantees optimal price-performance ratio
- Quick and easy adjustment of chip removal
- Precise planing tables made of aluminium for best results
- Dust hood (Ø 80 mm) can be used for both planing and thickening
- Cutterblock comes with HSS-knives
- Corrugated infeed roller ensures safe and consistent workpiece infeed
- Solid planer fence with prism guide can be tilted from 90° to 45°
- Serially equipped with knife gauge to allow accurate adjustment of knives
- Infeed can be switched off when planing



Thickening table is guided on four threads. The height can be read on the scale.



The ripped aluminium tables are slotted to reduce noise levels.



The precisely bedded cutterblock and corrugated infeed roller guarantees best planing results.

## Integrated dust extraction

Outfeed table is in upright position when thickening



### Optional accessories:

	Art. no.	excl. VAT
Planer knives 260 x 20 x 2,5 mm, price per pc.	15-1002	
Planer knife adjustment HML	08-1500	
Filter bag	97-80002	
Universal mobile base UFW 300	56-10705	

### Technical data

### PT 260

#### Planer

Planing width	260 mm
Table length	1050 mm
Table height	885 mm
Shaft rotation speed	6700 rpm
Cutter knives	2 pcs.
Planer shaft diameter	55 mm
Planer fence	610 x 110 mm
Fence tiltable	90° to 45°
Max. cutting depth	3 mm

#### Thicknesser

Table length	480 mm
Working width	250 mm
Working thickness, min./max.	5 - 150 mm
Max. cutting depth	2 mm
Feed speed	8 m/min

Dust extraction outlet	80 mm
Motor power output S <sub>1</sub> 100%	1,6 kW (2,1 HP)
Motor power input S <sub>6</sub> 40%	2,2 kW (3,0 HP)
Voltage	230 V or 400 V
Machine dimension (L x W x H)	1050 x 650 x 1050 mm
Weight approx.	75 kg
Art. no.	08-1022 (230 V) 08-1023 (400 V)

### Standard accessories:

- Cutter knives in HSS-quality
- Knife gauge
- Integrated dust extractor
- Waste bag
- Push handle

The PT 260 planer and thicknesser offers a wide range of standard accessories, including an integrated dust extractor, waste bag and knife gauge, making this model unbeatable in price-performance ratio for the price conscious user.

# PT 260



The planer fence with prism guide block can be tilted.



**BEST-PRICE!**

The machine is equipped with many safety devices to eliminate the risk of accidents.



The dust hood can be used for both planing and thicknessing.

**BERNARDO**<sup>®</sup>  
www.bernardo.at

**HOBBY**



**VOLTAGE**

Alternatively in  
230 V or 400 V

Serially equipped with integrated dust extractor and filter bag.

**BERNARDO**<sup>®</sup>  
www.bernardo.at

# Surface planer and thicknesser

# PT 260 S

- Reduction of noise level (approx. 50%) due to the standard spiral cutter head and up to 20 times the cutting edge life (results from four-way carbide inserts)
- Advantage of the carbide inserts: If damaged, individual knives can be exchanged or turned
- The carbide blades ensure tear-free planing results and optimal surfaces with any type of wood
- Both planing tables feature fine adjustment and are designed with slots to keep noise levels down
- Thicknessing table is guided on four threads to ensure accurate planing of boards, planks, etc.
- Integrated dust extractor guarantees optimal price-performance ratio
- Quick and easy adjustment of chip removal
- Precise planing tables made of aluminium for best results
- Corrugated infeed roller ensures safe and consistent workpiece infeed
- Solid planer fence with prism guide can be tilted from 90° to 45°



The planing unit consists of a dynamically balanced spiral cutter head, in- and outfeed roller and massive anti-kickback devices.



The rippled aluminium tables are slotted to reduce noise levels.

Spiral cutter head as standard

Integrated dust extraction

## VOLTAGE

Alternatively in  
230 V or 400 V

## NEW



### Standard accessories:

- Spiral cutter head with 24 pcs. TCT-blades
- Replacement TCT-blades (5 pcs.)
- Integrated dust extractor
- Waste bag
- Push handle

### Technical data

### PT 260 S

#### Planer

Planing width	260 mm
Table length	1050 mm
Table height	885 mm
Shaft rotation speed	6700 rpm
TCT-blades	24 pcs.
Planer shaft diameter	55 mm
Planer fence	640 x 125 mm
Fence tiltable	90° to 45°
Max. cutting depth	3 mm

#### Thicknesser

Table length	480 mm
Working width	250 mm
Working thickness, min./max.	5 - 150 mm
Max. cutting depth	2 mm
Feed speed	6 m/min

Dust extraction outlet	75 mm
Motor power output S <sub>1</sub> 100%	1,8 KW (2,4 HP)
Motor power input S <sub>6</sub> 40%	2,5 KW (3,4 HP)
Voltage	230 V or 400 V
Machine dimension (L x W x H)	1110 x 720 x 1030 mm
Weight approx.	89 kg
Art. no.	08-10220 (230 V) 08-10230 (400 V)

The PT 260 S planer and thicknesser offers a wide range of standard accessories, including an integrated dust extractor, waste bag and knife gauge, making this model unbeatable in price-performance ratio for the price conscious user. Another advantage is the spiral cutter head for reduced noise level and optimal planing results.

# PT 260 S



The planer fence with prism guide block can be tilted.



**Best Price**

The machine is equipped with many safety devices to eliminate the risk of accidents.



The dust hood can be used for both planing and thicknessing.

Serially equipped with integrated dust extractor and filter bag.



Optional accessories:	Art. no.	excl. VAT
TCT-blades for spiral cutter (10 pcs.)	15-1078	
Spare screws of spiral cutter blade (10 pcs.)	15-1079	
Torque wrench 6 Nm	15-1080	
Filter bag	97-80002	
Universal mobile base UFW 300	56-10705	

# Surface planer and thicknesser

# ADH 250 P

- Both planing tables feature fine adjustment and are designed with slots to keep noise level down
- Easy setting of chip removal (max. 2,5 mm)
- Torsion-free planing tables made out of solid cast iron
- Integrated, tiltable dust hood, extraction outlet 100 mm
- Precisely bedded 3-knife cutterblock incl. HSS-cutter knives
- Solid aluminium fence, tiltable from 90° to 45°
- Corrugated infeed rollers and rubber-coated outfeed rollers for optimal workpiece feed
- Workpiece infeed can be switched off when planing
- Tables can be tilted upright to allow easy workpiece infeed when thicknessing
- Thicknessing table with center column and support guarantees precise thicknessing
- Perfect machine for planing of boards, planks, beams etc.



The planing tables are designed with slots to keep noise levels to a minimum.

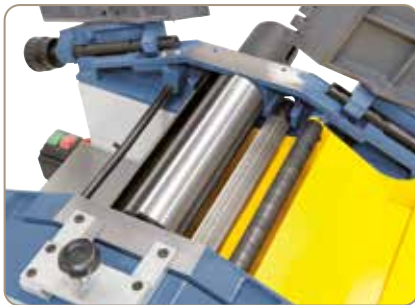

The planing unit consists of a 3-knife cutterblock, a corrugated infeed roller and rubber-coated outfeed roller.



The solid planer fence with prism guide can be adjusted easily and tilted up to 45°.

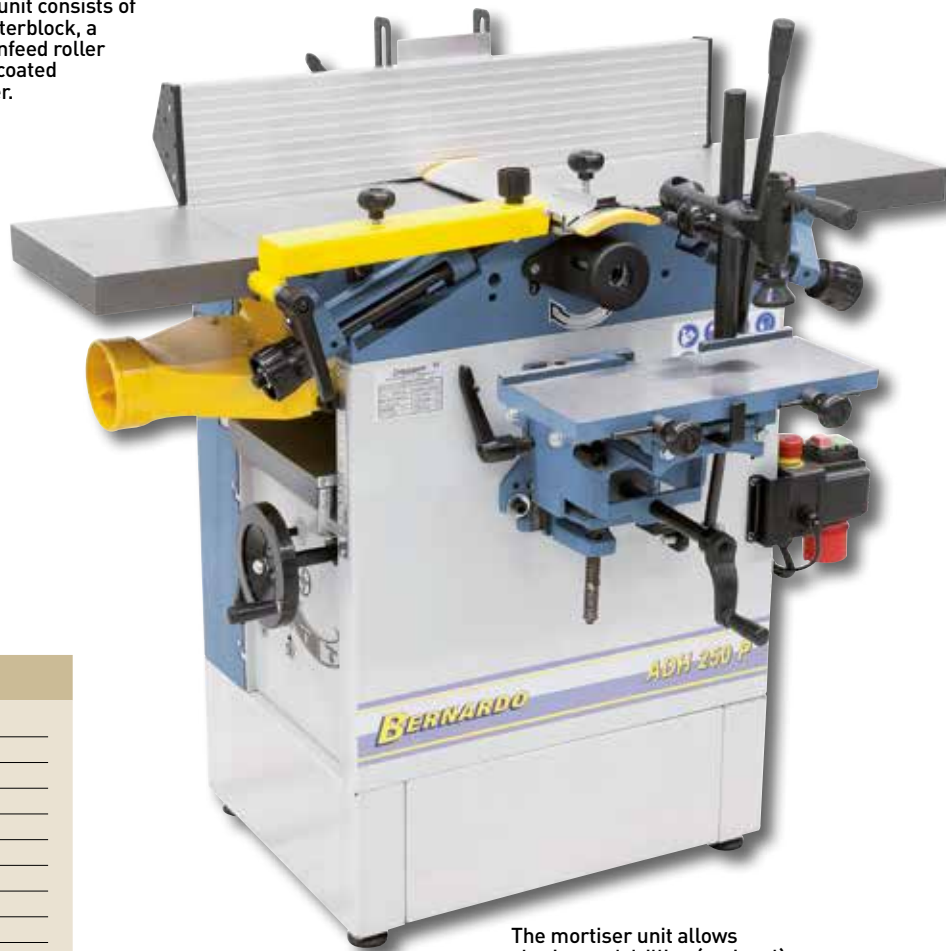

The mortiser unit allows slotting and drilling (optional).

## Technical data

## ADH 250 P

### Planer

Planing width	250 mm
Table length	1090 mm
Table height	830 mm
Shaft rotation speed	4000 rpm
Cutter knives	3 pcs.
Planer shaft diameter	75 mm
Planer fence	715 x 130 mm
Fence tiltable	90° to 45°
Max. cutting depth	5 mm

### Thicknesser

Table length	600 mm
Working width	245 mm
Working thickness, min./max.	5 - 185 mm
Max. cutting depth	2,5 mm
Feed speed	4,8 m/min

Dust extraction outlet	100 mm
Motor power output S <sub>1</sub> 100%	1,5 kW (2,0 HP)
Motor power input S <sub>6</sub> 40%	2,1 kW (2,8 HP)
Voltage	230 V or 400 V
Machine dimension (L x W x H)	1100 x 750 x 1010 mm
Weight approx.	148 kg
Art. no.	08-1018A (230 V) 08-1019A (400 V)

### Standard accessories:

- Cutter knives in HSS-quality
- Knife gauge
- 2 pcs. push handle

### Optional accessories:

Cutter knives 250 x 30 x 3 mm, price per pc.	15-1000	Art. no.	excl. VAT
Mortising unit	08-1549		
Mortising bit set 6 pcs., counterclockwise, 13 mm shaft	16-2003		
Dust collector DC 230 E / 230 V with tube (2,5 m)	12-2043		
PU-tube diam. 100 mm (6 m)	12-1077		
Universal mobile base UFW 300	56-10705		
Lubricant 1 kg, paste	54-1000		

The ADH 250 P planer and thicknesser is ideal for the precise planing of boards and planks. This model features a thickening height of 185 mm and the machine can optionally be equipped with a mortising unit for slotting and drilling works.

# ADH 250 P



The infeed function can be switched off when planing.



Quick and easy adjustment of chip removal.



Mortising unit optionally available



Foldable planer tables allow quick and easy conversion from planing to thicknessing.

## VOLTAGE

Alternatively in 230 V or 400 V



Thicknessing table with center column and support ensure accurate planing.

# Surface planer and thicknesser

# ADM 260

- Switch-plug-combination with motor brake as standard
- Folding planer tables allow quick and easy conversion from planing to thicknessing
- Integrated, tiltable dust hood, extraction outlet 100 mm
- Both planing tables feature fine adjustment and are designed with table lips to keep noise level down
- Maintenance-free 3-knife cutterblock with HSS 18% quality cutter knives
- Thicknessing table with central column and support allow precise planing
- The solid planer fence with prism guide can be tilted from 90° to 45°
- Torsion-free, cast iron planing tables guarantees best results
- Cutterblock cover according to CE-standards ensure safety
- Infeed can be switched off when planing



The solid planer fence with prism guide is tiltable up to 45°.

**Thousandfold  
established classic**



The dynamically balanced 3-knife cutterblock ensures smooth, vibration-free planing, guarantees best results.

A mortising unit is optionally available



**BERNARDO**  
www.bernardo.at  
**HOBBY**

## Standard accessories:

- Cutter knives in HSS-quality
- Knife gauge
- Switch-plug combination
- Push handle

## Technical data ADM 260

Planer	
Planing width	250 mm
Table length	1080 mm
Table height	990 mm
Shaft rotation speed	3750 rpm
Cutter knives	3 pcs.
Planer shaft diameter	75 mm
Planer fence	700 x 145 mm
Fence tiltable	90° to 45°
Max. cutting depth	5 mm
Thicknesser	
Table length	600 mm
Working width	250 mm
Working thickness, min./max.	5 - 190 mm
Max. cutting depth	1,8 mm
Feed speed	8 m/min
Dust extraction outlet	100 mm
Motor power output S <sub>1</sub> 100%	2,0 kW (2,7 HP)
Motor power input S <sub>6</sub> 40%	2,8 kW (3,8 HP)
Voltage	230 V or 400 V
Machine dimension (L x W x H)	1100 x 750 x 1180 mm
Weight approx.	160 kg
Art. no.	08-1030 (230 V) 08-1035 (400 V)

## Optional accessories:

Planer knives 250 x 30 x 3 mm, price per pc.	15-1000	excl. VAT
Planer knife adjustment HML	08-1500	
Spiral cutter head with 24 pcs. TCT-blades	15-1081	
TCT-blades for spiral cutter (10 pcs.)	15-1076	
Mortising unit	08-1549	
Mortising bit set 6 pcs. counterclockwise, 13 mm shaft	16-2003	
Dust collector DC 230 E / 230 V with tube (2,5 m)	12-2043	
Universal mobile base UFW 300	56-10705	
Lubricant 1 kg, paste	54-1000	

The powerful and strong planer and thicknesser ADM 260 is thousandfold established at the amateur area. The centrally guided thickening table and torsion-free planing tables guarantees precise results.

# ADM 260



The infeed function can be switched off when planing.



The optional mortising unit is optimal for slots, dowel pin and inclined bore, ...

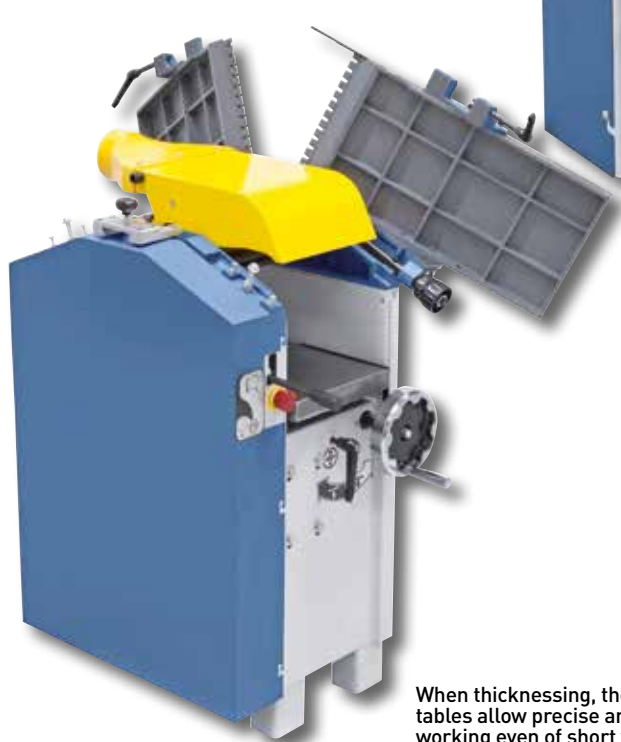

When thickening, the folding tables allow precise and safe working even of short workpieces.

## VOLTAGE

Alternatively in  
230 V or 400 V



Cast iron thickening table with center column and clamping, for planing of workpieces up to 190 mm in height.

# Surface planer and thicknesser with spiral cutter head

## ADM 260 S

- Reduction of noise level (approx. 50%) due to the standard spiral cutter head and up to 20 times the cutting edge life (results from four-way carbide inserts)
- Advantage of the carbide inserts: If damaged, individual knives can be exchanged or turned
- The carbide blades ensure tear-free planing results and optimal surfaces with any type of wood
- Folding planer tables allow quick and easy conversion from planing to thicknessing
- Integrated, tiltable dust hood, extraction outlet 100 mm
- Both planing tables feature fine adjustment and are designed with table lips to keep noise level down
- Thicknessing table with central column and support allow precise planing
- The solid planer fence with prism guide can be tilted from 90° to 45°
- Torsion-free, cast iron planing tables guarantees best results



The solid planer fence with prism guide is tiltable up to 45°.

### Spiral cutter head as standard

### Standard accessories:

- Spiral cutter head with 24 pcs. TCT-blades
- Replacement TCT-blades (5 pcs.)
- Switch-plug combination
- Push handle

Technical data	ADM 260 S
<b>Planer</b>	
Planing width	250 mm
Table length	1080 mm
Table height	990 mm
Shaft rotation speed	3750 rpm
TCT-blades	24 pcs.
Planer shaft diameter	75 mm
Planer fence	700 x 145 mm
Fence tiltable	90° to 45°
Max. cutting depth	5 mm
<b>Thicknesser</b>	
Table length	600 mm
Working width	250 mm
Working thickness, min./max.	5 - 190 mm
Max. cutting depth	1,8 mm
Feed speed	8 m/min
Dust extraction outlet	100 mm
Motor power output S <sub>1</sub> 100%	2,0 kW (2,7 HP)
Motor power input S <sub>6</sub> 40%	2,8 kW (3,8 HP)
Voltage	230 V or 400 V
Machine dimension (L x W x H)	1100 x 750 x 1180 mm
Weight approx.	160 kg
Art. no.	08-1036 (230 V) 08-1037 (400 V)

**BERNARDO**  
www.bernardo.at

**HOBBY**



The planing unit consists of a dynamically balanced cutter head, in- and out-feed rollers and massive anvil devices.

Optionally available universal base allows for easy transport.

### Optional accessories:

	Art. no.	excl. VAT
TCT-blades for spiral cutter (10 pcs.)	15-1076	
Spare screws of spiral cutter blade (10 pcs.)	15-1077	
Torque wrench 6 Nm	15-1080	
Mortising unit	08-1549	
Mortising bit set 6 pcs. counterclockwise, 13 mm shaft	16-2003	
Dust collector DC 230 E / 230 V with tube (2,5 m)	12-2043	
Universal mobile base UFW 300	56-10705	
Lubricant 1 kg, paste	54-1000	

The machine for the professional home user with an optimal price-to-performance ratio. It meets demands such as stability, high performance and safety. Another advantage is the spiral cutter head for reduced noise level and optimal planing results.

# ADM 260 S



The dynamically balanced spiral cutter head ensures smooth, vibration-free planing, guarantees best results.



sts of a  
spiral  
utfeed  
ti-kickback

Cast iron thickening table with center column and clamping, for planing of workpieces up to 190 mm in height.



When thickening, the folding tables allow precise and safe working even of short workpieces.

## VOLTAGE

Alternatively in  
230 V or 400 V



The infeed function can be switched off when planing.

# Surface planers and thicknesser

# AD 260

- Planing tables tilt to the back of the machine to keep space requirements to a minimum
- Precisely bedded, smooth running 3-knife cutterblock guarantees optimal results
- Integrated, tiltable dust hood, extraction outlet 100 mm
- Simultaneous tilting of planing tables to achieve maximum comfort
- Thickening table feed can be switched off when planing
- Hard-anodized aluminium planing fence, tiltable from 90° to 45°
- Thickening table with central column and support allow precise planing
- Torsion-free, cast iron planing tables guarantees best results
- Numerous safety devices: On/Off switch with undervoltage release, cutterblock cover in accordance with CE, limit switch to avoid accidental machine start,...



Solid thickening table with spindle guide and support for accurate planing of board, slats, planks etc.



The planing unit consists of a dynamically balanced 3-knife cutterblock, in- and outfeed roller and massive anti-kickback devices.



The table is designed with slots on both sides to minimize the noise level.

### 3-knife cutter-block as standard

#### Standard accessories:

- Cutter knives in HSS-quality
- Knife gauge
- Push handle



#### Technical data

#### AD 260

##### Planer

Planing width	250 mm
Table length	1090 mm
Table height	835 mm
Shaft rotation speed	4000 rpm
Cutter knives	3 pcs.
Planer shaft diameter	75 mm
Planer fence	715 x 130 mm
Fence tiltable	90° to 45°
Max. cutting depth	3 mm

##### Thicknesser

Table length	600 mm
Working width	250 mm
Working thickness, min./max.	5 - 185 mm
Max. cutting depth	2,5 mm
Feed speed	4,8 m/min

Dust extraction outlet	100 mm
Motor power output S <sub>1</sub> 100%	2,0 kW (2,7 HP)
Motor power input S <sub>6</sub> 40%	2,8 kW (3,8 HP)
Voltage	230 V or 400 V
Machine dimension (L x W x H)	1150 x 800 x 1000 mm
Weight approx.	173 kg
Art.no.	08-1051 (230 V) 08-1052 (400 V)

#### Optional accessories:

Cutter knife 250 x 30 x 3 mm, price per pc.	15-1000	Art. no.	excl. VAT
Spiral cutter head with 24 pcs. TCT-blades	15-1081		
TCT-blades for spiral cutter (10 pcs.)	15-1076		
Mortising unit	08-1549		
Mortising bit set 6 pcs. counterclockwise, 13 mm shaft	16-2003		
Dust collector DC 230 E / 230 V with tube (2,5 m)	12-2043		
Dust collector DC 230 E / 400 V with tube (2,5 m)	12-2044		
PU-tube diam. 100 mm (6 m)	12-1077		
Automatic start-up ALV 10 / 1 M	12-1150		
Lubricant 1 kg, paste	54-1000		

Introducing the AD 260 model, positioned for the professional home user with an optimal price-to-performance ratio. It meets demands such as stability, high performance and safety. Another advantage is the short conversion time from planing to thicknessing due to the simultaneous tilting of the planing tables.

# AD 260



Quick and easy adjustment of chip removal (up to 3 mm).

### Mortising unit optionally available

The large surface of the aluminium planing fence allows absolute accuracy when processing large, heavy workpieces.



**Best Price**

Simultaneous tilting of planing tables

### VOLTAGE

Alternatively in 230 V or 400 V

**BERNARDO**  
SEMIPROFESSIONAL



Simultaneous folding of planing tables ensure maximum comfort.



The optional mortising unit is ideal for drilling dowel, long and oblique holes.

# Surface planer and thicknesser with spiral cutter head

## AD 260 S

- Reduction of noise level (approx. 50%) due to the standard spiral cutter head and up to 20 times the cutting edge life (results from four-way carbide inserts)
- Advantage of the carbide inserts: If damaged, individual knives can be exchanged or turned
- Planing tables tilt to the back of the machine to keep space requirements to a minimum
- The carbide blades ensure tear-free planing results and optimal surfaces with any type of wood
- Simultaneous tilting of planing tables to achieve maximum comfort
- Thickening table feed can be switched off when planing
- Hard-anodized aluminium planing fence, tiltable from 90° to 45°
- Thickening table with central column and support allow precise planing
- Numerous safety devices: On/Off switch with undervoltage release, cutterblock cover in accordance with CE, limit switch to avoid accidental machine start,...



The planing unit consists of a dynamically balanced spiral cutter head, in- and outfeed roller and massive anti-kickback devices.



The table is designed with slots on both sides and a spiral cutter head to minimize the noise level.

### VOLTAGE

Alternatively in  
230 V or 400 V

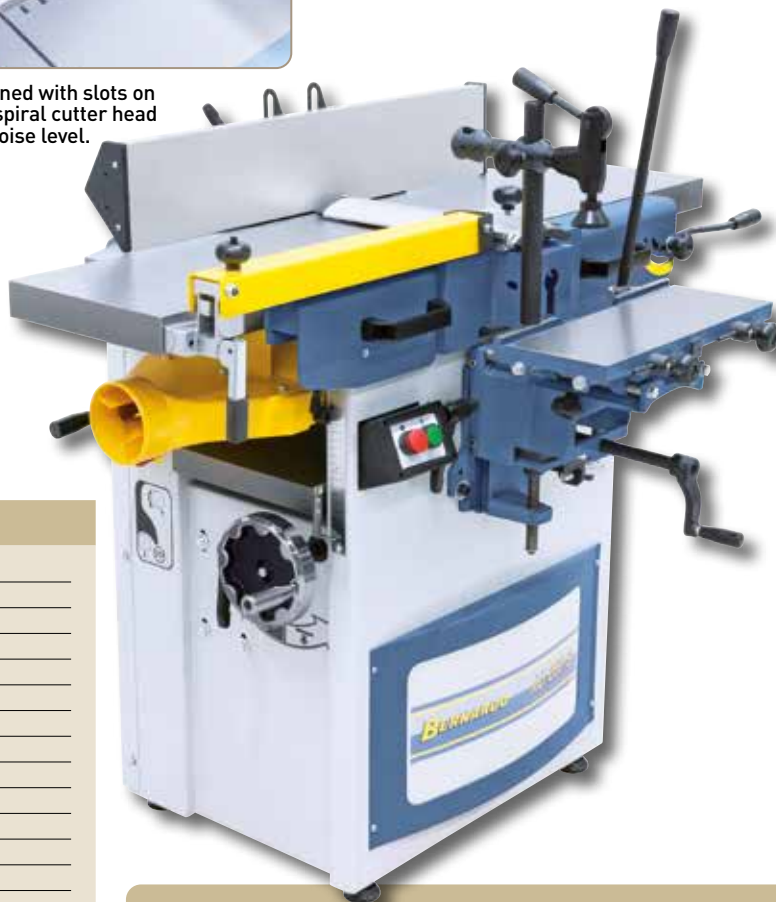

#### Standard accessories:

- Spiral cutter head with 24 pcs. TCT-blades
- Replacement TCT-blades (5 pcs.)
- Push handle

#### Technical data

#### AD 260 S

##### Planer

Planing width	250 mm
Table length	1090 mm
Table height	835 mm
Shaft rotation speed	4000 rpm
TCT-blades	24 pcs.
Planer shaft diameter	75 mm
Planer fence	715 x 130 mm
Fence tiltable	90° to 45°
Max. cutting depth	3 mm

##### Thicknesser

Table length	600 mm
Working width	250 mm
Working thickness, min./max.	5 - 185 mm
Max. cutting depth	2,5 mm
Feed speed	4,8 m/min

Dust extraction outlet	100 mm
Motor power output S <sub>1</sub> 100%	2,0 kW (2,7 HP)
Motor power input S <sub>6</sub> 40%	2,8 kW (3,8 HP)
Voltage	230 V or 400 V
Machine dimension (L x W x H)	1150 x 800 x 1000 mm
Weight approx.	173 kg
Art.no.	08-1053 (230 V) 08-1054 (400 V)

#### Optional accessories:

TCT-blades for spiral cutter (10 pcs.)	15-1076	Art. no.	excl. VAT
Spare screws of spiral cutter blade (10 pcs.)	15-1077		
Torque wrench 6 Nm	15-1080		
Mortising unit	08-1549		
Mortising bit set 6 pcs. counterclockwise, 13 mm shaft	16-2003		
Dust collector DC 230 E / 230 V with tube (2,5 m)	12-2043		
Dust collector DC 230 E / 400 V with tube (2,5 m)	12-2044		
PU-tube diam. 100 mm (6 m)	12-1077		
Automatic start-up ALV 10 / 1 M	12-1150		
Lubricant 1 kg, paste	54-1000		

The machine for the professional home user with an optimal price-to-performance ratio. It meets demands such as stability, high performance and safety. Another advantage is the spiral cutter head for reduced noise level and optimal planing results.

# AD 260 S



Quick and easy adjustment of chip removal (up to 3 mm).

**Spiral cutter head as standard**

The large surface of the aluminium planing fence allows absolute accuracy when processing large, heavy workpieces.



**Simultaneous tilting of planing tables**



Solid thickening table with spindle guide and support for accurate planing of board, slats, planks etc.



**BERNARDO**  
www.bernardo.at  
**SEMIPROFESSIONAL**

**Best Price**



Simultaneous folding of planing tables ensure maximum comfort.

**Mortising unit optionally available**



The optional mortising unit is ideal for drilling dowel, long and oblique holes.

# Surface planer and thicknesser

# PT 305 D

- Both planing tables feature fine adjustment and are designed with slots to keep noise levels down
- Thicknessing table is guided on four threads to ensure accurate planing of boards, planks, etc.
- Integrated dust extractor guarantees optimal price-performance ratio
- Quick and easy adjustment of chip removal
- Precise planing tables made of aluminium for best results
- Dust hood (Ø 100 mm) can be used for both planing and thicknessing
- Cutterblock comes with HSS-knives
- Corrugated infeed roller ensures safe and consistent workpiece infeed
- Solid planer fence with prism guide can be tilted from 90° to 45°
- Serially equipped with knife gauge to allow accurate adjustment of knives
- Infeed can be switched off when planing



Thicknessing table is guided on four threads. The height can be read on the scale.



Serially equipped with steering wheel and locking brake.

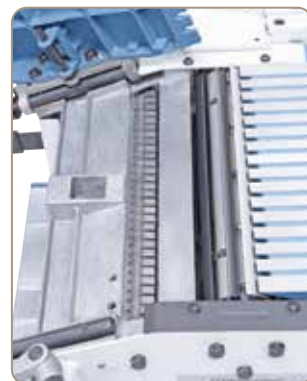

The precisely bedded cutterblock and corrugated infeed roller guarantees best planing results.

Integrated dust extraction

#### Optional accessories:

	Art. no.	excl. VAT
Set of planer knives in HSS-quality (2 pcs.)	15-1075	
Planer knife adjustment HML	08-1500	
Filter bag	97-79700	

#### Technical data

#### PT 305 D

##### Planer

Planing width	305 mm
Table length	1080 mm
Table height	920 mm
Shaft rotation speed	6700 rpm
Cutter knives	2 pcs.
Planer shaft diameter	62 mm
Planer fence	640 x 125 mm
Fence tiltable	90° to 45°
Max. cutting depth	3 mm

##### Thicknesser

Table length	500 mm
Working width	300 mm
Working thickness, min./max.	6 - 160 mm
Max. cutting depth	2 mm
Feed speed	8,5 m/min

Dust extraction outlet	100 mm / 75 mm
Motor power output S <sub>1</sub> 100%	1,8 KW (2,4 HP)
Motor power input S <sub>6</sub> 40%	2,5 KW (3,4 HP)
Voltage	230 V or 400 V
Machine dimension (L x W x H)	1140 x 820 x 1100 mm
Weight approx.	94 kg
Art. no.	08-1024 (230 V) 08-1025 (400 V)

#### Standard accessories:

- Cutter knives in HSS-quality
- Knife gauge
- Integrated dust extractor
- Waste bag
- 2x Push handle
- Carriage

**BERNARDO**  
www.bernardo.at  
**HOBBY**



The PT 305 D planer and thicknesser offers a wide range of standard accessories, including an integrated dust extractor, waste bag and knife gauge, making this model unbeatable in price-performance ratio for the price conscious user.

# PT 305 D



The planer fence with prism guide block can be tilted.



The machine is equipped with many safety devices to eliminate the risk of accidents.



The dust hood can be used for both planing and thicknessing.



Serially with carriage

**VOLTAGE**

Alternatively in  
230 V or 400 V

Serially equipped with integrated dust extractor and filter bag.

# Surface planer and thicknesser

## PT 305 DS

- Reduction of noise level (approx. 50%) due to the standard spiral cutter head and up to 20 times the cutting edge life (results from four-way carbide inserts)
- Advantage of the carbide inserts: If damaged, individual knives can be exchanged or turned
- The carbide blades ensure tear-free planing results and optimal surfaces with any type of wood
- Both planing tables feature fine adjustment and are designed with slots to keep noise levels down
- Thicknessing table is guided on four threads to ensure accurate planing of boards, planks, etc.
- Integrated dust extractor guarantees optimal price-performance ratio
- Quick and easy adjustment of chip removal
- Precise planing tables made of aluminium for best results
- Corrugated infeed roller ensures safe and consistent workpiece infeed
- Solid planer fence with prism guide can be tilted from 90° to 45°



The dynamically balanced spiral cutter head ensures smooth, vibration-free planing, guarantees best results.



Serially equipped with steering wheel and locking brake.

Spiral cutter head as standard

Integrated dust extraction

### VOLTAGE

Alternatively in  
230 V or 400 V

### NEW



#### Technical data

#### PT 305 DS

##### Planer

Planing width	305 mm
Table length	1080 mm
Table height	920 mm
Shaft rotation speed	6700 rpm
TCT-blades	28 pcs.
Planer shaft diameter	62 mm
Planer fence	640 x 125 mm
Fence tiltable	90° to 45°
Max. cutting depth	3 mm

##### Thicknesser

Table length	500 mm
Working width	305 mm
Working thickness, min./max.	5 - 160 mm
Max. cutting depth	2 mm
Feed speed	6 m/min

Dust extraction outlet	100 mm / 75 mm
Motor power output S <sub>1</sub> 100%	1,8 KW (2,4 HP)
Motor power input S <sub>6</sub> 40%	2,5 KW (3,4 HP)
Voltage	230 V or 400 V
Machine dimension (L x W x H)	1140 x 820 x 1100 mm
Weight approx.	98 kg
Art. no.	08-10240 (230 V) 08-10250 (400 V)

#### Standard accessories:

- Spiral cutter head with 28 pcs. TCT-blades
- Replacement TCT-blades (5 pcs.)
- Integrated dust extractor
- Waste bag
- Push handle
- Carriage

**BERNARDO**<sup>®</sup>  
www.bernardo.at  
**HOBBY**

The PT 305 DS planer and thicknesser offers a wide range of standard accessories, including an integrated dust extractor, waste bag and carriage, making this model unbeatable in price-performance ratio for the price conscious user. Another advantage is the spiral cutter head for reduced noise level and optimal planing results.

# PT 305 DS



The planer fence with prism guide block can be tilted.



The machine is equipped with many safety devices to eliminate the risk of accidents.



The dust hood can be used for both planing and thicknessing.



Serially equipped with integrated dust extractor and filter bag.



Serially with carriage

**Optional accessories:**

- TCT-blades for spiral cutter (10 pcs.)
- Spare screws of spiral cutter blade (10 pcs.)
- Torque wrench 6 Nm
- Filter bag

Art. no.	excl. VAT
15-1078	
15-1079	
15-1080	
97-79700	

# Surface planer and thicknesser

# FS 310 P

- Planing tables fold to the backside of the machine to minimize space requirements
- Integrated tiltable dust hood, extraction outlet 100 mm
- Digital display on handwheel features 1/10 mm scaling for precise adjustment of thicknessing table
- Anodized aluminium planing fence, tilts from 90° to 45°
- Powerful motor for optimal planing results
- Quick and easy adjustment of chip removal
- Simultaneous folding of planing tables allows fast conversion from planing to thicknessing
- Ergonomically arranged control elements and switches
- Several safety devices: On/Off switch with undervoltage release, cutterblock cover in accordance with CE, limit switch to avoid accidental machine start
- Precisely bedded 3-knife cutterblock with HSS-knives



Solid thicknessing table with spindle guide and support for accurate planing of board, slats, planks etc.



Tables can be adjusted precisely - 1/10 mm - using the digital display.

## VOLTAGE

Alternatively in  
230 V or 400 V



Simultaneous folding of planing tables ensure maximum comfort.

Serial with  
digital height adjustment

Mortising unit  
optionally available

### Technical data FS 310 P

Planer	
Planing width	310 mm
Table length	1400 mm
Table height	825 mm
Shaft rotation speed	4500 rpm
Cutter knives	3 pcs.
Planer shaft diameter	75 mm
Planer fence	1120 x 150 mm
Fence tiltable	90° to 45°
Max. cutting depth	3 mm
Thicknesser	
Table length	600 mm
Working width	305 mm
Working thickness, min./max.	5 - 240 mm
Max. cutting depth	3 mm
Feed speed	5,4 m/min
Dust extraction outlet	100 mm
Motor power output S <sub>1</sub> 100%	3,0 kW (4,0 HP)
Motor power input S <sub>6</sub> 40%	4,2 kW (5,7 HP)
Voltage	230 V or 400 V
Machine dimension (L x W x H)	1400 x 900 x 980 mm
Weight approx.	205 kg
Art. no.	08-1045 (230 V) 08-1046 (400 V)

### Standard accessories:

- Cutter knives in HSS-quality
- Knife gauge
- Push handle
- Digital display for thicknessing table

### Optional accessories:

Planer knives 310 x 30 x 3 mm, price per pc.	Art. no. 15-1005
Planer knives adjustment HML	08-1500
Spiral cutter head with 30 pcs. TCT-blades	15-10810
TCT-blades for spiral cutter (10 pcs.)	15-1076
Mortising unit	08-1549
Mortising bit set 6 pcs. counterclockwise, 13 mm shaft	16-2003
Dust collector DC 300 / 400 V	12-2045
PU-tube diam. 100 mm (6 m)	12-1077
Automatic start-up ALV 10 / 1 M	12-1150
Automatic start-up system ALV 2 / M 230 - 230 V	12-1152
Universal mobile base UFW 300	56-10705
Lubricant 1 kg, paste	54-1000

The FS 310 P planing and thickening machine was developed with an emphasis on safety, rigidity, compact construction and high user comfort, making this model meet the demands of experienced users.

# FS 310 P



Quick and easy adjustment of chip removal (up to 3 mm).

The large surface of the aluminium planing fence allows absolute accuracy when processing large, heavy workpieces.



**Simultaneous tilting of planing tables**

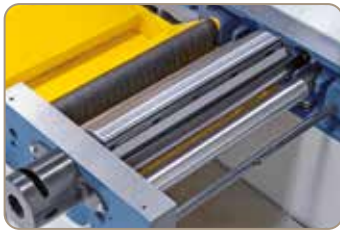

The solid planing unit features a precisely bedded 3-knife cutterblock to guarantee best results.



The long, reinforced, grey cast iron planing / thickening tables allow precise processing of large workpieces.



The planer fence can be set to required position via the precise prism guide.

**BERNARDO**  
www.bernardo.at  
**HOBBY**

# Surface planer and thicknesser with spiral cutter head

## FS 310 PS

- Reduction of noise level (approx. 50%) due to the standard spiral cutter head and up to 20 times the cutting edge life (results from four-way carbide inserts)
- Advantage of the carbide inserts: If damaged, individual knives can be exchanged or turned
- Planing tables fold to the backside of the machine to minimize space requirements
- The carbide blades ensure tear-free planing results and optimal surfaces with any type of wood
- Integrated tiltable dust hood, extraction outlet 100 mm
- Digital display on handwheel features 1/10 mm scaling for precise adjustment of thicknessing table
- Anodized aluminium planing fence, tilts from 90° to 45°
- Powerful motor for optimal planing results
- Quick and easy adjustment of chip removal
- Simultaneous folding of planing tables allows fast conversion from planing to thicknessing
- Several safety devices: On/Off switch with undervoltage release, cutterblock cover in accordance with CE, limit switch to avoid accidental machine start



Tables can be adjusted precisely - 1/10 mm - using the digital display.

**BERNARDO®**  
www.bernardo.at

**HOBBY**



Optionally available universal base allows for easy transport.

Serial with digital height adjustment

Simultaneous tilting of planing tables

### Technical data

### FS 310 PS

#### Planer

Planing width	310 mm
Table length	1400 mm
Table height	825 mm
Shaft rotation speed	4500 rpm
TCT-blades	30 pcs.
Planer shaft diameter	75 mm
Planer fence	1120 x 150 mm
Fence tiltable	90° to 45°
Max. cutting depth	3 mm

#### Thicknesser

Table length	600 mm
Working width	305 mm
Working thickness, min./max.	5 - 240 mm
Max. cutting depth	3 mm
Feed speed	5,4 m/min

Dust extraction outlet	100 mm
Motor power output S <sub>1</sub> 100%	3,0 kW (4,0 HP)
Motor power input S <sub>6</sub> 40%	4,2 kW (5,7 HP)
Voltage	230 V or 400 V
Machine dimension (L x W x H)	1400 x 900 x 980 mm
Weight approx.	205 kg
Art.no.	08-1043 (230 V) 08-1044 (400 V)

### Standard accessories:

- Spiral cutter head with 24 pcs. TCT-blades
- Replacement TCT-blades (5 pcs.)
- Digital display for thicknessing table
- Push handle

### Optional accessories:

TCT-blades for spiral cutter (10 pcs.)	15-1076
Spare screws of spiral cutter blade (10 pcs.)	15-1077
Torque wrench 6 Nm	15-1080
Mortising unit	08-1549
Mortising bit set 6 pcs. counterclockwise, 13 mm shaft	16-2003
Dust collector DC 300 / 400 V	12-2045
PU-tube diam. 100 mm (6 m)	12-1077
Automatic start-up ALV 10 / 1 M	12-1150
Automatic start-up system ALV 2 / M 230 - 230 V	12-1152
Universal mobile base UFW 300	56-10705
Lubricant 1 kg, paste	54-1000

Art. no. excl. VAT

The machine for the professional home user with an optimal price-to-performance ratio. It meets demands such as stability, high performance and safety. Another advantage is the spiral cutter head for reduced noise level and optimal planing results.

# FS 310 PS



Quick and easy adjustment of chip removal (up to 3 mm).

The large surface of the aluminium planing fence allows absolute accuracy when processing large, heavy workpieces.



The solid planing unit features a precisely bedded spiral cutter head to guarantee best results.



Mortising unit optionally available

## VOLTAGE

Alternatively in 230 V or 400 V

The long, reinforced, grey cast iron planing / thickening tables allow precise processing of large workpieces.



The planer fence can be set to required position via the precise prism guide.

# Surface planer and thicknesser

# PT 310

- Integrated tiltable dust hood, extraction outlet 100 mm
- Folding planing tables allows fast conversion from planer to thicknesser
- Switch-plug-combination with motor brake
- Solid planing fence with prism guide, tiltable from 90° - 45°
- Both planing tables feature fine adjustment and are designed with table lips to keep noise level down
- Maintenance-free 3-knife cutterblock with HSS-quality cutter knives
- Feed can be switched off when surface planing
- Cutterblock in accordance with CE allow for safe working conditions
- Thicknessing table guided by centre column and support for accurate planing
- Torsion-free, grey cast-iron planing tables for best planing results



Grey cast-iron thicknessing table features centre column and support, for workpieces up to 180 mm in height.



The optional mortising unit is ideal for drilling dowel, long and oblique holes.

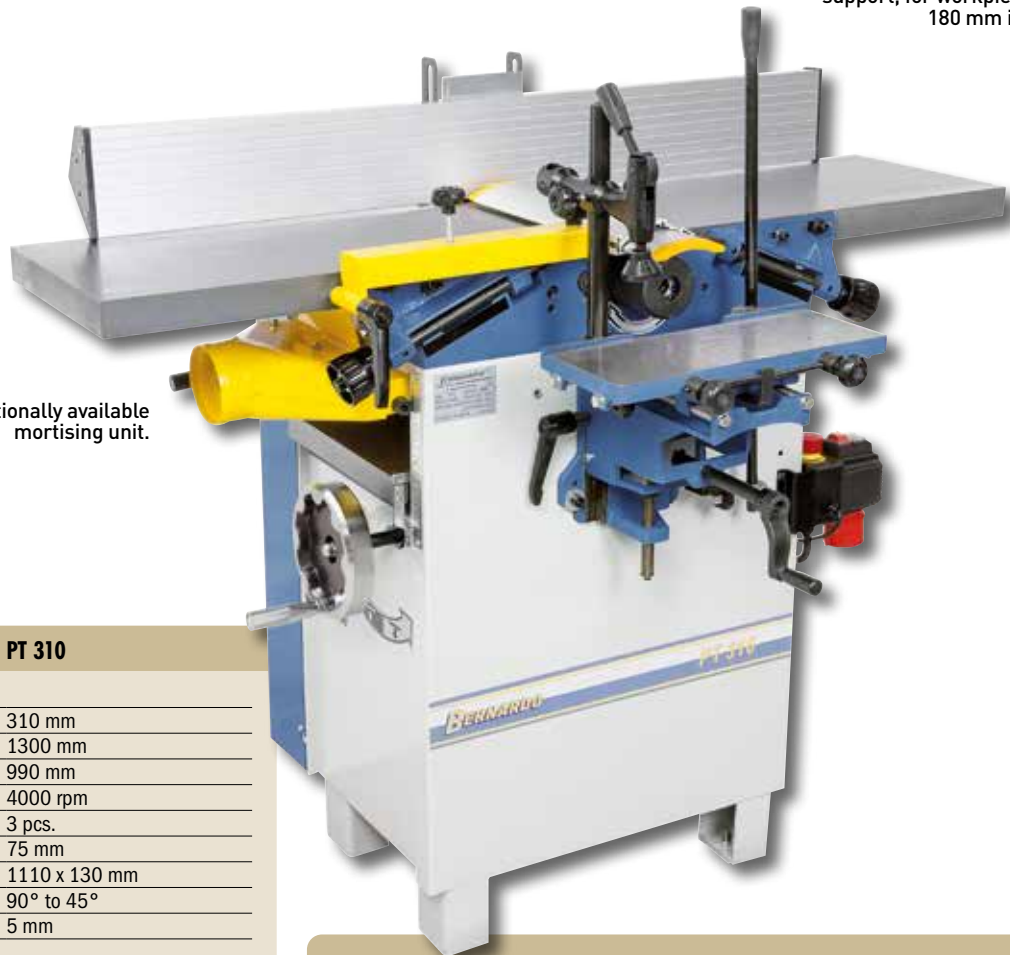

Picture shows optionally available mortising unit.

## Standard accessories:

- Cutter knives in HSS-quality
- Knife gauge
- Switch-plug-combination
- Push handle

## Technical data

## PT 310

### Planer

Planing width	310 mm
Table length	1300 mm
Table height	990 mm
Shaft rotation speed	4000 rpm
Cutter knives	3 pcs.
Planer shaft diameter	75 mm
Planer fence	1110 x 130 mm
Fence tiltable	90° to 45°
Max. cutting depth	5 mm

### Thicknesser

Table length	600 mm
Working width	305 mm
Working thickness, min./max.	5 - 180 mm
Max. cutting depth	2,5 mm
Feed speed	8 m/min

Dust extraction outlet	100 mm
Motor power output S <sub>1</sub> 100%	2,2 kW (3,0 HP)
Motor power input S <sub>6</sub> 40%	3,0 kW (4,0 HP)
Voltage	400 V
Machine dimension (L x W x H)	1300 x 900 x 1180 mm
Weight approx.	180 kg
Art. no.	08-1041

## Optional accessories:

Planer knives 310 x 30 x 3 mm, price per pc.	15-1005	Art. no.	excl. VAT
Planer knives adjustment HML	08-1500		
Spiral cutter head with 30 pcs. TCT-blades	15-10810		
TCT-blades for spiral cutter (10 pcs.)	15-1076		
Mortising unit	08-1549		
Mortising bit set 6 pcs. counterclockwise, 13 mm shaft	16-2003		
Dust collector DC 300 / 400 V	12-2045		
Dust collector DC 400 / 400 V	12-2060		
PU-tube diam. 100 mm (6 m)	12-1077		
Universal mobile base UFW 300	56-10705		
Lubricant 1 kg, paste	54-1000		
Automatic start-up ALV 10 / 1 M	12-1150		

The PT 310 compact surface planer and thicknesser features a working thickness of up to 180 mm, making it the ideal model for planing of boards, planks and beams. The optionally available mortising unit makes the machine suitable for drilling and slotting.

# PT 310

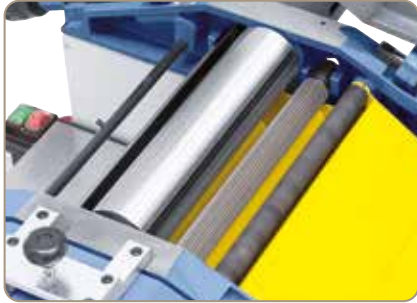

The planing unit consists of a dynamically balanced 3-knife cutterblock, in- and outfeed roller and massive anti-kickback devices.

The large support area of the long planing fence guarantees precision when working on large workpieces.



Feed can be switched off when surface planing.



**BEST-PRICE!**



Folding planing tables allow for quick and easy conversion from planing to thicknessing.



Several protective devices ensure high user safety.

# Surface planer and thicknesser with spiral cutter head

## PT 310 S

- Reduction of noise level (approx. 50%) due to the standard spiral cutter head and up to 20 times the cutting edge life (results from four-way carbide inserts)
- Advantage of the carbide inserts: If damaged, individual knives can be exchanged or turned
- Integrated tiltable dust hood, extraction outlet 100 mm
- The carbide blades ensure tear-free planing results and optimal surfaces with any type of wood
- Folding planing tables allows fast conversion from planer to thicknesser
- Solid planing fence with prism guide, tiltable from 90° - 45°
- Both planing tables feature fine adjustment and are designed with table lips to keep noise level down
- Cutterblock in accordance with CE allow for safe working conditions
- Thickening table guided by centre column and support for accurate planing
- Torsion-free, grey cast-iron planing tables for best planing results



The optional mortising unit is ideal for drilling dowel, long and oblique holes.

**BERNARDO**  
www.bernardo.at  
**HOBBY**



Picture shows optionally available mortising unit.

### Standard accessories:

- Spiral cutter head with 30 pcs. TCT-blades
- Replacement TCT-blades (5 pcs.)
- Switch-plug-combination
- Push handle

Technical data	PT 310 S
<b>Planer</b>	
Planing width	310 mm
Table length	1300 mm
Table height	990 mm
Shaft rotation speed	4000 rpm
TCT-blades	30 pcs.
Planer shaft diameter	75 mm
Planer fence	1110 x 130 mm
Fence tiltable	90° to 45°
Max. cutting depth	5 mm
<b>Thicknesser</b>	
Table length	600 mm
Working width	305 mm
Working thickness, min./max.	5 - 180 mm
Max. cutting depth	2,5 mm
Feed speed	8 m/min
Dust extraction outlet	100 mm
Motor power output S <sub>1</sub> 100%	2,2 kW (3,0 HP)
Motor power input S <sub>6</sub> 40%	3,0 kW (4,0 HP)
Voltage	400 V
Machine dimension (L x W x H)	1300 x 900 x 1180 mm
Weight approx.	180 kg
Art. no.	08-1039

### Optional accessories:

- TCT-blades for spiral cutter (10 pcs.)
- Spare screws of spiral cutter blade (10 pcs.)
- Torque wrench 6 Nm
- Mortising unit
- Mortising bit set 6 pcs. counterclockwise, 13 mm shaft
- Dust collector DC 300 / 400 V
- Dust collector DC 400 / 400 V
- PU-tube diam. 100 mm (6 m)
- Universal mobile base UFW 300
- Lubricant 1 kg, paste
- Automatic start-up ALV 10 / 1 M

**BEST-PRICE!**

Art. no.	excl. VAT
15-1076	
15-1077	
15-1080	
08-1549	
16-2003	
12-2045	
12-2060	
12-1077	
56-10705	
54-1000	
12-1150	

The PT 310 S compact surface planer and thicknesser features a working thickness of up to 180 mm, making it the ideal model for planing of boards, planks and beams. The optionally available mortising unit makes the machine suitable for drilling and slotting. Another advantage is the spiral cutter head for reduced noise level and optimal planing results.

# PT 310 S

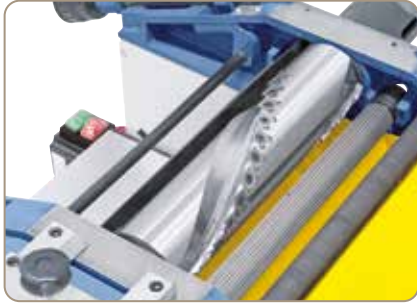

The large support area of the long planing fence guarantees precision when working on large workpieces.



**Spiral cutter head as standard**

The planing unit consists of a dynamically balanced spiral cutter head, in- and outfeed roller and massive anti-kickback devices.



Grey cast-iron thickening table features centre column and support, for workpieces up to 180 mm in height.



Folding planing tables allow for quick and easy conversion from planing to thicknessing.



Feed can be switched off when surface planing.

# Surface planers and thicknessers

# ADM 300 ADM 300 V

- Folding planing tables for quick conversion to thicknessing
- Integrated tiltable dust hood, extraction outlet 100 mm
- Both planing tables feature fine adjustment and noise absorbing table lips
- Maintenance-free 4-knife cutterblock with 18% quality HSS- knives
- Spiral toothed infeed roller for safe and consistent workpiece infeed
- Thicknessing table with central column and support for a high level of accuracy
- Planing fence positioned to side of machine, allowing machine to be flush with wall
- Model ADM 300 V comes with stepless feed speed adjustment (1 - 10 m/min)
- Serially equipped with knife gauge to ensure precise adjustment of cutter knives
- Powerful, high performance motor



The mortising unit is ideal for drilling slots, dowels and inclined bores (optional).



The precisely bedded 4-knife cutterblock and the spiral toothed infeed roller ensure best results.



The table lips in combination with the perforated chip plate keep the noise level to a minimum.

**Stepless  
speed adjustment**

ADM 300 V

**BERNARDO®**  
www.bernardo.at  
**HOBBY**

## Standard accessories:

- Cutter knives in HSS-quality
- Knife gauge
- Integrated carriage
- Stepless infeed (ADM 300 V)
- Digital display for thicknessing table (ADM 300 V)
- Push handle

Technical data	ADM 300	ADM 300 V
<b>Planer</b>		
Planing width	305 mm	305 mm
Table length	1510 mm	1510 mm
Table height	915 mm	915 mm
Shaft rotation speed	5500 rpm	5500 rpm
Cutter knives	4 pcs.	4 pcs.
Planer shaft diameter	78 mm	78 mm
Planer fence	1105 x 155 mm	1105 x 155 mm
Fence tiltable	90° to 45°	90° to 45°
Max. cutting depth	3 mm	3 mm
<b>Thicknesser</b>		
Table length	585 mm	585 mm
Working width	300 mm	300 mm
Working thickness, min./max.	3 - 220 mm	3 - 220 mm
Max. cutting depth	3 mm	3 mm
Feed speed	6,6 m/min	1 - 10 m/min, stepless
Dust extraction outlet	100 mm	100 mm
Motor power output S <sub>1</sub> 100%	3,0 kW (4,0 HP)	3,0 kW (4,0 HP)
Motor power input S <sub>6</sub> 40%	4,2 kW (5,7 HP)	4,2 kW (5,7 HP)
Voltage	400 V	400 V
Machine dimension (L x W x H)	1700 x 790 x 1080 mm	1700 x 790 x 1080 mm
Weight approx.	280 kg	280 kg
Art. no.	08-1085	08-1087A



## Optional accessories:

	Art. no.	excl. VAT
Cutter knife 305 x 25 x 3 mm, price per pc.	15-1004	
Mortising unit	08-1088	
Mortising bit set 6 pcs. counterclockwise, 13 mm shaft	16-2003	
Dust collector DC 300 / 400 V	12-2045	
PU-tube diam. 100 mm (6 m)	12-1077	
Automatic start-up ALV 10 / 1 M	12-1150	
Lubricant 1 kg, paste	54-1000	

These machines offer the ideal price-performance ratio for the well-advanced amateur. These machines meet all the users' requirements with features like a high level of stability and quick conversion while providing large power resources. Additionally, the ADM 300 V features a stepless feed speed, ensuring ideal adjustment to the workpiece.

# ADM 300 ADM 300 V



The planer fence is positioned to the side of the machine to keep the required space to a minimum.



The long surface of the aluminum planer fence allows precise guiding of heavy and large workpieces.



Serially with carriage



The stepless speed adjustment is ideal for different workpieces (ADM 300 V).

Serial with digital height adjustment



Ergonomically arranged control elements to set chip removal.

# Surface planers and thicknessers

# AD 310

- Planing tables tilt to the back of the machine to keep space requirements to a minimum
- Precisely bedded, smooth running 4-knife cutterblock guarantees optimal results
- Integrated, tiltable dust hood, extraction outlet 100 mm
- Simultaneous tilting of planing tables to achieve maximum comfort
- Thicknessing table feed can be switched off when planing
- Hard-anodized aluminium planing fence, tiltable from 90° to 45°
- Thicknessing table with central column and support allow precise planing
- Torsion-free, cast iron planing tables guarantees best results
- Numerous safety devices: On/Off switch with undervoltage release, cutterblock cover in accordance with CE, limit switch to avoid accidental machine start,...



Solid thicknessing table with spindle guide and support for accurate planing of board, slats, planks etc.



The planing unit consists of a dynamically balanced 4-knife cutterblock, in- and outfeed roller and massive anti-kickback devices.

### 4-knife cutterblock as standard



The table is designed with slots on both sides to minimize the noise level.



### Standard accessories:

- Cutter knives in HSS-quality
- Knife gauge
- Push handle

Technical data	AD 310
<b>Planer</b>	
Planing width	310 mm
Table length	1610 mm
Table height	910 mm
Shaft rotation speed	4300 rpm
Cutter knives	4 pcs.
Planer shaft diameter	95 mm
Planer fence	1110 x 150 mm
Fence tiltable	90° to 45°
Max. cutting depth	3 mm
<b>Thicknesser</b>	
Table length	750 mm
Working width	310 mm
Working thickness, min./max.	5 - 225 mm
Max. cutting depth	5 mm
Feed speed	6 m/min
Dust extraction outlet	100 mm
Motor power output S <sub>1</sub> 100%	3,0 kW (4,0 HP)
Motor power input S <sub>6</sub> 40%	4,2 kW (5,7 HP)
Voltage	400 V
Machine dimension (L x W x H)	1610 x 900 x 1150 mm
Weight approx.	295 kg
Art.no.	08-1064

### Optional accessories:

	Art. no.	excl. VAT
Cutter knife 310 x 30 x 3 mm, price per pc.	15-1005	
Spiral cutter head with 52 pcs. TCT-blades	15-108120	
TCT-blades for spiral cutter (10 pcs.)	15-1078	
Mortising unit	08-1068	
Mortising bit set 6 pcs. counterclockwise, 13 mm shaft	16-2003	
Dust collector DC 300 / 400 V	12-2045	
PU-tube diam. 100 mm (6 m)	12-1077	
Automatic start-up ALV 10 / 1 M	12-1150	
Lubricant 1 kg, paste	54-1000	

Introducing the AD 310 model, positioned for the professional home user with an optimal price-to-performance ratio. It meets demands such as stability, high performance and safety. Another advantage is the short conversion time from planing to thickening due to the simultaneous tilting of the planing tables.

# AD 310



Quick and easy adjustment of chip removal (up to 3 mm).

### Mortising unit optionally available

The large surface of the aluminium planing fence allows absolute accuracy when processing large, heavy workpieces.



### Simultaneous tilting of planing tables

**Best Price**

**BERNARDO**  
www.bernardo.at  
**SEMIPROFESSIONAL**



Simultaneous folding of planing tables ensure maximum comfort.



The optional mortising unit is ideal for drilling dowel, long and oblique holes.

# Surface planer and thicknesser with spiral cutter head

## AD 310 S

- Reduction of noise level (approx. 50%) due to the standard spiral cutter head and up to 20 times the cutting edge life (results from four-way carbide inserts)
- Advantage of the carbide inserts: If damaged, individual knives can be exchanged or turned
- Planing tables tilt to the back of the machine to keep space requirements to a minimum
- Integrated, tiltable dust hood, extraction outlet 100 mm
- The carbide blades ensure tear-free planing results and optimal surfaces with any type of wood
- Simultaneous tilting of planing tables to achieve maximum comfort
- Hard-anodized aluminium planing fence, tiltable from 90° to 45°
- Thicknessing table with central column and support allow precise planing
- Torsion-free, cast iron planing tables guarantees best results
- Numerous safety devices: On/Off switch with undervoltage release, cutterblock cover in accordance with CE, limit switch to avoid accidental machine start,...



The planing unit consists of a dynamically balanced spiral cutter head, in- and outfeed roller and massive anti-kickback devices.



Solid thickening table with spindle guide and support for accurate planing of board, slats, planks etc.

**BERNARDO**  
www.bernardo.at  
**SEMIPROFESSIONAL**

Spiral cutter head as standard



### Standard accessories:

- Spiral cutter head with 56 pcs. TCT-blades
- Replacement TCT-blades (5 pcs.)
- Push handle

Technical data	AD 310 S
<b>Planer</b>	
Planing width	310 mm
Table length	1610 mm
Table height	910 mm
Shaft rotation speed	4300 rpm
TCT-blades	52 pcs.
Planer shaft diameter	95 mm
Planer fence	1110 x 150 mm
Fence tiltable	90° to 45°
Max. cutting depth	3 mm
<b>Thicknesser</b>	
Table length	750 mm
Working width	310 mm
Working thickness, min./max.	5 - 225 mm
Max. cutting depth	5 mm
Feed speed	6 m/min
Dust extraction outlet	100 mm
Motor power output S <sub>1</sub> 100%	3,0 kW (4,0 HP)
Motor power input S <sub>6</sub> 40%	4,2 kW (5,7 HP)
Voltage	400 V
Machine dimension (L x W x H)	1610 x 900 x 1150 mm
Weight approx.	295 kg
Art.no.	08-1066

### Optional accessories:

	Art. no.	excl. VAT
TCT-blades for spiral cutter (10 pcs.)	15-1078	
Spare screws of spiral cutter blade (10 pcs.)	15-1079	
Torque wrench 6 Nm	15-1080	
Mortising unit	08-1068	
Mortising bit set 6 pcs. counterclockwise, 13 mm shaft	16-2003	
Dust collector DC 300 / 400 V	12-2045	
PU-tube diam. 100 mm (6 m)	12-1077	
Automatic start-up ALV 10 / 1 M	12-1150	
Lubricant 1 kg, paste	54-1000	

Introducing the AD 310 S model, positioned for the professional home user with an optimal price-to-performance ratio. It meets demands such as stability, high performance and safety. Another advantage is the short conversion time from planing to thicknessing due to the simultaneous tilting of the planing tables and the spiral cutter head for reduced noise level and optimal planing results.

# AD 310 S



Quick and easy adjustment of chip removal (up to 3 mm).

### Mortising unit optionally available

The large surface of the aluminium planing fence allows absolute accuracy when processing large, heavy workpieces.



### Simultaneous tilting of planing tables

**Best Price**



Simultaneous folding of planing tables ensure maximum comfort.



The optional mortising unit is ideal for drilling dowel, long and oblique holes.

# Surface planer and thicknesser

# FS 410 P

- Planing tables fold to the backside of the machine to minimize space requirements
- Integrated tiltable dust hood, extraction outlet 100 mm
- Digital display on handwheel features 1/10 mm scaling for precise adjustment of thicknessing table
- Anodized aluminium planing fence, tilts from 90° to 45°
- Powerful motor for optimal planing results
- Quick and easy adjustment of chip removal
- Simultaneous folding of planing tables allows fast conversion from planing to thicknessing
- Ergonomically arranged control elements and switches
- Several safety devices: On/Off switch with undervoltage release, cutterblock cover in accordance with CE, limit switch to avoid accidental machine start
- Precisely bedded 3-knife cutterblock with HSS-knives



Solid thicknessing table with spindle guide and support for accurate planing of board, slats, planks etc.



Tables can be adjusted precisely - 1/10 mm - using the digital display.

Serial with digital height adjustment



Simultaneous folding of planing tables ensure maximum comfort.

## Standard accessories:

- Cutter knives in HSS-quality
- Knife gauge
- Digital display for thicknessing table
- Table extension with rolls
- Push handle

**NEW**



## Technical data

## FS 410 P

### Planer

Planing width	410 mm
Table length	1685 mm
Table height	850 mm
Shaft rotation speed	4300 rpm
Cutter knives	3 pcs.
Planer shaft diameter	70 mm
Planer fence	1115 x 150 mm
Fence tiltable	90° to 45°
Max. cutting depth	3,5 mm

### Thicknesser

Table length	995* mm
Working width	410 mm
Working thickness, min./max.	5 - 240 mm
Max. cutting depth	4,5 mm
Feed speed	5,4 m/min

Dust extraction outlet	100 mm
Motor power output S <sub>1</sub> 100%	3,0 kW (4,0 HP)
Motor power input S <sub>6</sub> 40%	4,2 kW (5,7 HP)
Voltage	400 V
Machine dimension (L x W x H)	1685x 990 x 1010 mm
Weight approx.	261 kg
Art. no.	08-1057

\* with table extension

## Optional accessories:

Planer knives 410 x 30 x 3 mm, price per pc.	15-1016	excl. VAT
Planer knives adjustment HML	08-1500	
Spiral cutter head with 72 pcs. TCT-blades	15-108110	
TCT-blades for spiral cutter (10 pcs.)	15-1078	
Mortising unit	08-10680	
Mortising bit set 6 pcs. counterclockwise, 13 mm shaft	16-2003	
Dust collector DC 300 / 400 V	12-2045	
Dust collector DC 450 CF / 400 V	12-2095	
PU-tube diam. 100 mm (6 m)	12-1077	
Automatic start-up ALV 10 / 1 M	12-1150	
Universal mobile base UWF 300	56-10705	
Lubricant 1 kg, paste	54-1000	

The FS 410 P combined planer and thicknesser machine feature optimal price to benefit and is best suitable for professional users. This machine meet all the users requirements with features like a high level of stability and quick conversion while providing large power resources. The dual lift of both planer tables reduce conversion time to thicknessing significantly.

# FS 410 P



Quick and easy adjustment of chip removal (up to 3,5 mm).

The large surface of the aluminium planing fence allows absolute accuracy when processing large, heavy workpieces.



**Silmultaneous tilting of planing tables**



The solid planing unit features a precisely bedded 3-knife cutterblock to guarantee best results.



**Mortising unit optionally available**

The long, reinforced, grey cast iron planing / thicknessing tables allow precise processing of large workpieces.



The planer fence can be set to required position via the precise prism guide.

**BERNARDO**  
www.bernardo.at  
**SEMI PROFESSIONAL**

# Surface planer and thicknesser with spiral cutter head

## FS 410 PS

- Reduction of noise level (approx. 50%) due to the standard spiral cutter head and up to 20 times the cutting edge life (results from four-way carbide inserts)
- Advantage of the carbide inserts: If damaged, individual knives can be exchanged or turned
- Planing tables fold to the backside of the machine to minimize space requirements
- The carbide blades ensure tear-free planing results and optimal surfaces with any type of wood
- Integrated tiltable dust hood, extraction outlet 100 mm
- Digital display on handwheel features 1/10 mm scaling for precise adjustment of thicknessing table
- Anodized aluminium planing fence, tilts from 90° to 45°
- Powerful motor for optimal planing results
- Quick and easy adjustment of chip removal
- Simultaneous folding of planing tables allows fast conversion from planing to thicknessing
- Several safety devices: On/Off switch with undervoltage release, cutterblock cover in accordance with CE, limit switch to avoid accidental machine start



Tables can be adjusted precisely - 1/10 mm - using the digital display.

**BERNARDO®**  
www.bernardo.at  
**SEMIPROFESSIONAL**



Serial with digital height adjustment

Simultaneous tilting of planing tables

### Technical data

### FS 410 PS

#### Planer

Planing width	410 mm
Table length	1685 mm
Table height	850 mm
Shaft rotation speed	4300 rpm
TCT-blades	72 pcs.
Planer shaft diameter	70 mm
Planer fence	1115 x 150 mm
Fence tiltable	90° to 45°
Max. cutting depth	3,5 mm

#### Thicknesser

Table length	995* mm
Working width	410 mm
Working thickness, min./max.	5 - 240 mm
Max. cutting depth	4,5 mm
Feed speed	5,4 m/min

Dust extraction outlet	100 mm
Motor power output S <sub>1</sub> 100%	3,0 kW (4,0 HP)
Motor power input S <sub>6</sub> 40%	4,2 kW (5,7 HP)
Voltage	400 V
Machine dimension (L x W x H)	1685x 990 x 1010 mm
Weight approx.	261 kg
Art.no.	08-1058

\* with table extension

### Standard accessories:

- Spiral cutter head with 72 pcs. TCT-blades
- Replacement TCT-blades (5 pcs.)
- Digital display for thicknessing table
- Table extension with rolls
- Push handle

### Optional accessories:

TCT-blades for spiral cutter (10 pcs.)	15-1078
Spare screws of spiral cutter blade (10 pcs.)	15-1077
Torque wrench 6 Nm	15-1080
Mortising unit	08-10680
Mortising bit set 6 pcs. counterclockwise, 13 mm shaft	16-2003
Dust collector DC 300 / 400 V	12-2045
Dust collector DC 450 CF / 400 V	12-2095
PU-tube diam. 100 mm (6 m)	12-1077
Automatic start-up ALV 10 / 1 M	12-1150
Universal mobile base UFW 300	56-10705
Lubricant 1 kg, paste	54-1000

Art. no. excl. VAT

The FS 410 PS is a compact planer and thicknesser with a thickening height of 240 mm – ideal for precise planing of boards, planks and beams. To widen the application range the optionally available mortising unit can be added to allow slotting and drilling. Another advantage is the spiral cutter head for reduced noise level and optimal planing results.

# FS 410 PS



Quick and easy adjustment of chip removal (up to 3,5 mm).

The large surface of the aluminium planing fence allows absolute accuracy when processing large, heavy workpieces.



**NEW**



The solid planing unit features a precisely bedded spiral cutter head to guarantee best results.

**Mortising unit optionally available**



The planer fence can be set to required position via the precise prism guide.

The long, reinforced, grey cast iron planing / thicknessing tables allow precise processing of large workpieces.

# Surface planer and thicknesser

# PT 410

- Solid planer fence with prism guide, tiltable from 90° to 45°
- Maintenance-free 4-knife cutterblock features HSS-quality cutter knives
- Tiltable planer tables for quick conversion to thicknessing
- Both planer tables feature fine adjustment and table slots to reduce noise levels
- Integrated tiltable dust hood – extraction outlet 100 mm
- Feed can be switched off when planing
- Switch-plug-combination with motor brake
- Torsion-free, grey cast-iron planer tables ensure best results
- Cutterblock guard in accordance with CE-standards guarantees high level of safety
- Thicknessing table runs on central column and is well supported for high accuracy



The precisely bedded 4-knife cutterblock and the straight-toothed of the infeed roller ensure top work results.

4-knife cutterblock as standard



The grey cast-iron planer tables with polished surface guarantees an optimal sliding capacity of the workpiece.

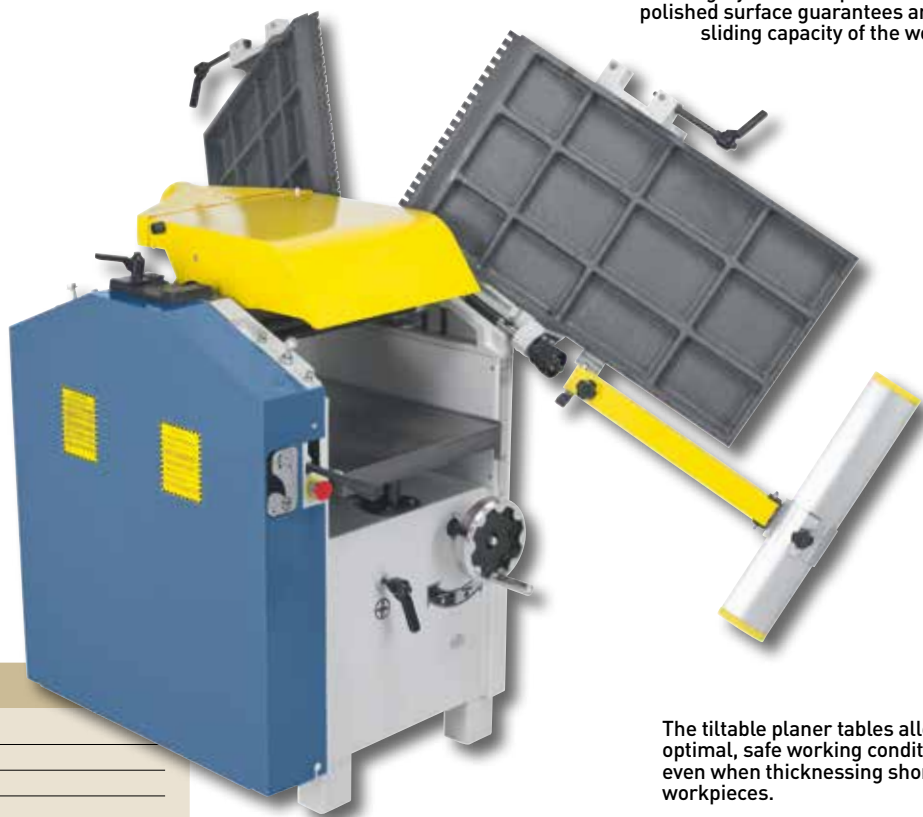

The tiltable planer tables allow optimal, safe working conditions even when thicknessing short workpieces.

## Technical data

PT 410

### Planer

Planing width	410 mm
Table length	1600 mm
Table height	920 mm
Shaft rotation speed	4000 rpm
Cutter knives	4 pcs.
Planer shaft diameter	95 mm
Planer fence	1120 x 130 mm
Fence tiltable	90° to 45°
Max. cutting depth	5 mm

### Thicknesser

Table length	750 mm
Working width	410 mm
Working thickness, min./max.	4 - 220 mm
Max. cutting depth	2,5 mm
Feed speed	8 m/min

Dust extraction outlet	100 mm
Motor power output S <sub>1</sub> 100%	3,0 kW (4,0 HP)
Motor power input S <sub>6</sub> 40%	4,2 kW (5,7 HP)
Voltage	400 V
Machine dimension (L x W x H)	1610 x 1050 1100 mm
Weight approx.	340 kg
Art. no.	08-1061

## Standard accessories:

- Cutter knives in HSS-quality
- Knife gauge
- Switch-plug-combination
- Push handle

## Optional accessories:

Planer knives 410 x 30 x 3 mm, price per pc.	15-1016	Art. no.	excl. VAT
Planer knife adjustment HML	08-1500		
Spiral cutter head with 72 pcs. TCT-blades	15-108110		
TCT-blades for spiral cutter (10 pcs.)	15-1078		
Mortising unit	08-1550		
Mortising bit set 6 pcs., counterclockwise, 13 mm shaft	16-2003		
Dust collector DC 300 / 400 V	12-2045		
Dust collector DC 400 / 400 V	12-2060		
PU-tube diam. 100 mm (6 m)	12-1077		
Automatic start-up ALV 10 / 1 M	12-1150		
Automatic start-up ALV 2 / M 230 - 230 V	12-1152		
Lubricant 1 kg, paste	54-1000		

The PT 410 is a compact planer and thicknesser with a thickening height of 220 mm – ideal for precise planing of boards, planks and beams. To widen the application range the optionally available mortising unit can be added to allow slotting and drilling.

# PT 410



The planer fence can be set to required position via the precise prism guide.

Both planer tables are equipped with table lips to reduce noise.



**BERNARDO**<sup>®</sup>  
www.bernardo.at  
**HOBBY**

**BEST-PRICE!**



PT 410 with optional mortising unit.



The mortising unit is ideal for drilling deep holes, dowels and oblique holes etc.

# Surface planer and thicknesser with spiral cutter head

## PT 410 S

- Reduction of noise level (approx. 50%) due to the standard spiral cutter head and up to 20 times the cutting edge life (results from four-way carbide inserts)
- Advantage of the carbide inserts: If damaged, individual knives can be exchanged or turned
- Solid planer fence with prism guide, tiltable from 90° to 45°
- The carbide blades ensure tear-free planing results and optimal surfaces with any type of wood
- Tiltable planer tables for quick conversion to thicknessing
- Both planer tables feature fine adjustment and table slots to reduce noise levels
- Integrated tiltable dust hood – extraction outlet 100 mm
- Torsion-free, grey cast-iron planer tables ensure best results
- Cutterblock guard in accordance with CE-standards guarantees high level of safety
- Thicknessing table runs on central column and is well supported for high accuracy



The precisely bedded spiral cutter head and the straight toothed of the infeed roller ensure top work results.

### Standard accessories:

- Spiral cutter head with 72 pcs. TCT-blades
- Replacement TCT-blades (5 pcs.)
- Switch-plug-combination
- Push handle



The tiltable planer tables allow optimal, safe working conditions even when thicknessing short workpieces.

### Technical data

### PT 410 S

#### Planer

Planing width	410 mm
Table length	1600 mm
Table height	920 mm
Shaft rotation speed	4000 rpm
TCT-blades	72 pcs.
Planer shaft diameter	95 mm
Planer fence	1120 x 130 mm
Fence tiltable	90° to 45°
Max. cutting depth	5 mm

#### Thicknesser

Table length	750 mm
Working width	410 mm
Working thickness, min./max.	4 - 220 mm
Max. cutting depth	2,5 mm
Feed speed	8 m/min

Dust extraction outlet	100 mm
Motor power output S <sub>1</sub> 100%	3,0 kW (4,0 HP)
Motor power input S <sub>6</sub> 40%	4,2 kW (5,7 HP)
Voltage	400 V
Machine dimension (L x W x H)	1610 x 1050 1100 mm
Weight approx.	340 kg
Art. no.	08-1063

### Spiral cutter head as standard

### Optional accessories:

	Art. no.	excl. VAT
TCT-blades for spiral cutter (10 pcs.)	15-1078	
Spare screws of spiral cutter blade (10 pcs.)	15-1079	
Torque wrench 6 Nm	15-1080	
Mortising unit	08-1550	
Mortising bit set 6 pcs., counterclockwise, 13 mm shaft	16-2003	
Dust collector DC 300 / 400 V	12-2045	
Dust collector DC 400 / 400 V	12-2060	
PU-tube diam. 100 mm (6 m)	12-1077	
Automatic start-up ALV 10 / 1 M	12-1150	
Automatic start-up ALV 2 / M 230 - 230 V	12-1152	
Lubricant 1 kg, paste	54-1000	

The PT 410 S is a compact planer and thicknesser with a thickening height of 220 mm – ideal for precise planing of boards, planks and beams. To widen the application range the optionally available mortising unit can be added to allow slotting and drilling. Another advantage is the spiral cutter head for reduced noise level and optimal planing results.

# PT 410 S



The planer fence can be set to required position via the precise prism guide.

The grey cast-iron planer tables with polished surface guarantees an optimal sliding capacity of the workpiece.



**BERNARDO**  
www.bernardo.at  
**HOBBY**

**BEST-PRICE!**



PT 410 with optional mortising unit.



The mortising unit is ideal for drilling deep holes, dowels and oblique holes etc.

# Surface planer and thicknesser

# AD 410

- Planing tables tilt to the back of the machine to keep space requirements to a minimum
- Precisely bedded, smooth running 4-knife cutterblock guarantees optimal results
- Integrated, tiltable dust hood, extraction outlet 100 mm
- Simultaneous tilting of planing tables to achieve maximum comfort
- Thickening table feed can be switched off when planing
- Hard-anodized aluminium planing fence, tiltable from 90° to 45°
- Thickening table with central column and support allow precise planing
- Torsion-free, cast iron planing tables guarantees best results
- Numerous safety devices: On/Off switch with undervoltage release, cutterblock cover in accordance with CE, limit switch to avoid accidental machine start,...



Solid thickening table with spindle guide and support for accurate planing of board, slats, planks etc.



The planing unit consists of a dynamically balanced 4-knife cutterblock, in- and outfeed roller and massive anti-kickback devices.

### 4-knife cutterblock as standard

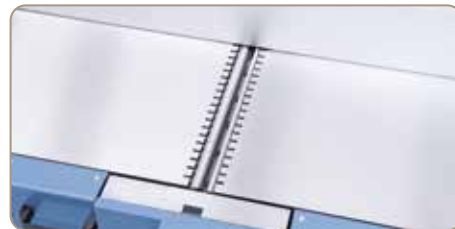

The table is designed with slots on both sides to minimize the noise level.

### Standard accessories:

- Cutter knives in HSS-quality
- Knife gauge
- Push handle

Technical data	AD 410
<b>Planer</b>	
Planing width	410 mm
Table length	1685 mm
Table height	920 mm
Shaft rotation speed	4300 rpm
Cutter knives	4 pcs.
Planer shaft diameter	95 mm
Planer fence	1110 x 150 mm
Fence tiltable	90° to 45°
Max. cutting depth	3 mm
<b>Thicknesser</b>	
Table length	750 mm
Working width	410 mm
Working thickness, min./max.	4 - 220 mm
Max. cutting depth	5 mm
Feed speed	6 m/min
Dust extraction outlet	100 mm
Motor power output S <sub>1</sub> 100%	3,0 kW (4,0 HP)
Motor power input S <sub>6</sub> 40%	4,2 kW (5,7 HP)
Voltage	400 V
Machine dimension (L x W x H)	1685 x 1045 x 1100 mm
Weight approx.	340 kg
Art.no.	08-1067



Simultaneous folding of planing tables ensure maximum comfort.

### Optional accessories:

Cutter knife 410 x 30 x 3 mm, price per pc.	15-1016	excl. VAT
Spiral cutter head with 72 pcs. TCT-blades	15-108111	
TCT-blades for spiral cutter (10 pcs.)	15-1078	
Mortising unit	08-1068	
Mortising bit set 6 pcs. counterclockwise, 13 mm shaft	16-2003	
Dust collector DC 300 / 400 V	12-2045	
PU-tube diam. 100 mm (6 m)	12-1077	
Automatic start-up ALV 10 / 1 M	12-1150	
Lubricant 1 kg, paste	54-1000	

The AD 410 combined planer and thicknesser machine feature optimal price to benefit and is best suitable for professional users. This machine meet all the users requirements with features like a high level of stability and quick conversion while providing large power resources. The dual lift of both planer tables reduce conversion time to thicknessing significantly.

# AD 410



**Mortising unit  
optionally available**



The large surface of the aluminium planing fence allows absolute accuracy when processing large, heavy workpieces.

Quick and easy adjustment of chip removal (up to 3 mm).



**Simultaneous tilting  
of planing tables**

**Best  
Price**

**BERNARDO**  
www.bernardo.at  
**SEMIPROFESSIONAL**



Integrated, tiltable dust hood, extraction outlet 100 mm



The infeed function can be switched off when planing.



The mortising unit is ideal for drilling deep holes, dowels and oblique holes etc.

# Surface planer and thicknesser with spiral cutter head

## AD 410 S

- Reduction of noise level (approx. 50%) due to the standard spiral cutter head and up to 20 times the cutting edge life (results from four-way carbide inserts)
- Advantage of the carbide inserts: If damaged, individual knives can be exchanged or turned
- Planing tables tilt to the back of the machine to keep space requirements to a minimum
- The carbide blades ensure tear-free planing results and optimal surfaces with any type of wood
- Simultaneous tilting of planing tables to achieve maximum comfort
- Thicknessing table feed can be switched off when planing
- Hard-anodized aluminium planing fence, tiltable from 90° to 45°
- Thicknessing table with central column and support allow precise planing
- Torsion-free, cast iron planing tables guarantees best results
- Numerous safety devices: On/Off switch with undervoltage release, cutterblock cover in accordance with CE, limit switch to avoid accidental machine start,...



The planing unit consists of a dynamically balanced spiral cutter head, in- and outfeed roller and massive anti-kickback devices.



Solid thickening table with spindle guide and support for accurate planing of board, slats, planks etc.

### Standard accessories:

- Spiral cutter head with 72 pcs. TCT-blades
- Replacement TCT-blades (5 pcs.)
- Push handle

Technical data	AD 410 S
<b>Planer</b>	
Planing width	410 mm
Table length	1685 mm
Table height	920 mm
Shaft rotation speed	4300 rpm
TCT-blades	72 pcs.
Planer shaft diameter	95 mm
Planer fence	1110 x 150 mm
Fence tiltable	90° to 45°
Max. cutting depth	3 mm
<b>Thicknesser</b>	
Table length	750 mm
Working width	410 mm
Working thickness, min./max.	4 - 220 mm
Max. cutting depth	5 mm
Feed speed	6 m/min
Dust extraction outlet	100 mm
Motor power output S <sub>1</sub> 100%	3,0 kW (4,0 HP)
Motor power input S <sub>6</sub> 40%	4,2 kW (5,7 HP)
Voltage	400 V
Machine dimension (L x W x H)	1685 x 1045 x 1100 mm
Weight approx.	340 kg
Art.no.	08-1069

Simultaneous folding of planing tables ensure maximum comfort.



Spiral cutter head as standard

### Optional accessories:

	Art. no.	excl. VAT
TCT-blades for spiral cutter (10 pcs.)	15-1078	
Spare screws of spiral cutter blade (10 pcs.)	15-1079	
Torque wrench 6 Nm	15-1080	
Mortising unit	08-1068	
Mortising bit set 6 pcs. counterclockwise, 13 mm shaft	16-2003	
Dust collector DC 300 / 400 V	12-2045	
PU-tube diam. 100 mm (6 m)	12-1077	
Automatic start-up ALV 10 / 1 M	12-1150	
Lubricant 1 kg, paste	54-1000	

# AD 410 S

The AD 410 S combined planer and thicknesser machine feature optimal price to benefit and is best suitable for professional users. This machine meet all the users requirements with features like a high level of stability and quick conversion while providing large power resources. The dual lift of both planer tables reduce conversion time to thicknessing significantly. Another advantage is the spiral cutter head for reduced noise level and optimal planing results.



Mortising unit optionally available



The planer fence can be set to required position via the precise prism guide.

Quick and easy adjustment of chip removal (up to 3 mm).



Simultaneous tilting of planing tables

Best Price

**BERNARDO**  
www.bernardo.at  
**SEMIPROFESSIONAL**



Integrated, tiltable dust hood, extraction outlet 100 mm



The infeed function can be switched off when planing.



The mortising unit is ideal for drilling deep holes, dowels and oblique holes etc.

# Surface planing machine

# SP 150 PN

The planing machine SP 150 PN is designed for accurate planing, jointing and chamfering of boards, planks etc. at entry level. The heavy cast iron frame and precise construction meet the requirements of ambitious amateurs and craftsmen.

- Cutterblock features HSS-planing knives
- Ideal for planing of boards, planks etc.
- Most accurate grey cast iron planing tables guarantees excellent results
- Extremely long planing tables with ground surface assure perfectly smooth results
- On/Off button with undervoltage release
- Solid cast iron planing fence, tiltable from 90° to 45°
- Handwheel allows easy adjustment of chip removal
- Solid construction eliminates vibrations



The solidly built, up to 45° tiltable planer fence can easily be adjusted.



The planing fence features a solid tilting device including adjustable end stops

## VOLTAGE

Alternatively in  
230 V or 400 V

### Standard accessories:

- Cutter knives in HSS-Quality
- Knife gauge
- 2 x push handle

Technical data	SP 150 PN
Planing width	150 mm
Table length	1230 mm
Table height	820 mm
Infeed table length	590 mm
Outfeed table length	585 mm
Planer fence	740 x 100 mm
Cutter knives	3 pcs.
Planer shaft diameter	60 mm
Shaft rotation speed	4500 rpm
Max. cutting depth	8 mm
Dust extraction outlet	100 mm
Motor power output S <sub>1</sub> 100%	1,1 kW (1,5 HP)
Motor power input S <sub>6</sub> 40%	1,5 kW (2,0 HP)
Voltage	230 V or 400 V
Machine dimension (L x W x H)	1230 x 530 x 1180 mm
Weight approx.	115 kg
Art. no.	08-10130 (230 V) 08-10131 (400 V)



Serially equipped with On/Off switch according to IP 54 including undervoltage release.

**BERNARDO**  
SEMIPROFESSIONAL



### Optional accessories:

Cutter knives 153 x 17 x 3 mm, price per pc.  
Spiral cutter head with 28 pcs. TCT-blades  
TCT-blades for spiral cutter (10 pcs.)  
PU-tube diam. 100 mm (6 m)  
Dust collector DC 230 E / 230 V with tube (2,5 m)  
Universal mobile base UFW 300

Art. no.    excl. VAT  
15-0989  
15-10813  
15-1078  
12-1077  
12-2043  
56-10705

# Surface planing machine with spiral cutter head

# SP 150 PS

- Reduction of noise level (approx. 50%) due to the standard spiral cutter head and up to 20 times the cutting edge life (results from four-way carbide inserts)
- Advantage of the carbide inserts: If damaged, individual knives can be exchanged or turned
- Ideal for planing of boards, planks etc.
- The carbide blades ensure tear-free planing results and optimal surfaces with any type of wood
- Most accurate grey cast iron planing tables guarantees excellent results
- Extremely long planing tables with ground surface assure perfectly smooth results
- On/Off button with undervoltage release
- Solid cast iron planing fence, tiltable from 90° to 45°
- Handwheel allows easy adjustment of chip removal
- Solid construction eliminates vibrations



The solid planing unit features a precisely bedded spiral cutter head to guarantee best results.



Quick and easy adjustment of chip removal (up to 8 mm).



## Standard accessories:

- Spiral cutter head with 28 pcs. TCT-blades
- Replacement TCT-blades (5 pcs.)
- 2 x push handle

Technical data	SP 150 PS
Planing width	150 mm
Table length	1230 mm
Table height	820 mm
Infeed table length	590 mm
Outfeed table length	585 mm
Planer fence	740 x 100 mm
TCT-blades	28 pcs.
Planer shaft diameter	60 mm
Shaft rotation speed	4500 rpm
Max. cutting depth	8 mm
Dust extraction outlet	100 mm
Motor power output S <sub>1</sub> 100%	1,1 kW (1,5 HP)
Motor power input S <sub>6</sub> 40%	1,5 kW (2,0 HP)
Voltage	230 V or 400 V
Machine dimension (L x W x H)	1230 x 530 x 1180 mm
Weight approx.	115 kg
Art. no.	08-10132 (230 V) 08-10133 (400 V)

Spiral cutter head  
as standard

## Optional accessories:

- TCT-blades for spiral cutter (10 pcs.)
- Spare screws of spiral cutter blade (10 pcs.)
- Torque wrench 6 Nm
- PU-tube diam. 100 mm (6 m)
- Dust collector DC 230 E / 230 V with tube (2,5 m)
- Universal mobile base UWF 300

Art. no.	excl. VAT
15-1078	
15-1079	
15-1080	
12-1077	
12-2043	
56-10705	

# Surface planing machine

# SP 200 PN

The planing machine SP 200 PN is designed for accurate planing, jointing and chamfering of boards, planks etc. at entry level. The heavy cast iron frame and precise construction meet the requirements of ambitious amateurs and craftsmen.

- Cutterblock features HSS-planing knives
- Ideal for planing of boards, planks etc.
- Most accurate grey cast iron planing tables guarantees excellent results
- Extremely long planing tables with ground surface assure perfectly smooth results
- On/Off button with undervoltage release
- Solid cast iron planing fence, tiltable from 90° to 45°
- Handwheel allows easy adjustment of chip removal
- Solid construction eliminates vibrations



Several protective devices ensure high user safety.



The planing fence features a solid tilting device including adjustable end stops



Handwheel allows easy adjustment of chip removal

**BERNARDO**  
SEMIPROFESSIONAL



**VOLTAGE**

Alternatively in  
230 V or 400 V

## Technical data

## SP 200 PN

Planing width	200 mm
Table length	1805 mm
Table height	840 mm
Infeed table length	880 mm
Outfeed table length	880 mm
Planer fence	1020 x 125 mm
Cutter knives	4 pcs.
Planer shaft diameter	72 mm
Shaft rotation speed	4800 rpm
Max. cutting depth	8 mm
Dust extraction outlet	100 mm
Motor power output S <sub>1</sub> 100%	2,2 kW (3,0 HP)
Motor power input S <sub>6</sub> 40%	3,0 kW (4,0 HP)
Voltage	230 V or 400 V
Machine dimension (L x W x H)	1805 x 660 x 1200 mm
Weight approx.	181 kg
Art. no.	08-10140 (230 V) 08-10141 (400 V)

## Standard accessories:

- Cutter knives in HSS-Quality
- Knife gauge
- 2 x push handle

**4-knife cutter-block as standard**

## Optional accessories:

- Cutter knives 205 x 17 x 2,5 mm, price per pc.
- Spiral cutter head with 36 pcs. TCT-blades
- TCT-blades for spiral cutter (10 pcs.)
- PU-tube diam. 100 mm (6 m)
- Dust collector DC 230 E / 230 V with tube (2,5 m)
- Digital angle finder
- Universal mobile base UFW 300

Art. no.	excl. VAT
15-0988	
15-10814	
15-1078	
12-1077	
12-2043	
31-1044	
56-10705	

# Surface planing machine with spiral cutter head

# SP 200 PS

- Reduction of noise level (approx. 50%) due to the standard spiral cutter head and up to 20 times the cutting edge life (results from four-way carbide inserts)
- Advantage of the carbide inserts: If damaged, individual knives can be exchanged or turned
- Ideal for planing of boards, planks etc.
- The carbide blades ensure tear-free planing results and optimal surfaces with any type of wood
- Most accurate grey cast iron planing tables guarantees excellent results
- Extremely long planing tables with ground surface assure perfectly smooth results
- On/Off button with undervoltage release
- Solid cast iron planing fence, tiltable from 90° to 45°
- Handwheel allows easy adjustment of chip removal
- Solid construction eliminates vibrations



The solidly built, up to 45° tiltable planer fence can easily be adjusted.

Planer fence  
made of cast iron

Spiral cutter head  
as standard



The solid planing unit features a precisely bedded spiral cutter head to guarantee best results.



## VOLTAGE

Alternatively in  
230 V or 400 V

**BERNARDO**  
SEMIPROFESSIONAL

### Technical data

### SP 200 PS

Planing width	200 mm
Table length	1805 mm
Table height	840 mm
Infeed table length	880 mm
Outfeed table length	880 mm
Planer fence	1020 x 125 mm
TCT-blades	36 pcs.
Planer shaft diameter	72 mm
Shaft rotation speed	4800 rpm
Max. cutting depth	8 mm
Dust extraction outlet	100 mm
Motor power output S <sub>1</sub> 100%	2,2 kW (3,0 HP)
Motor power input S <sub>6</sub> 40%	3,0 kW (4,0 HP)
Voltage	230 V or 400 V
Machine dimension (L x W x H)	1805 x 660 x 1200 mm
Weight approx.	181 kg
Art. no.	08-10142 (230 V) 08-10143 (400 V)

### Standard accessories:

- Spiral cutter head with 36 pcs. TCT-blades
- Replacement TCT-blades (5 pcs.)
- 2 x push handle

### Optional accessories:

- TCT-blades for spiral cutter (10 pcs.)
- Spare screws of spiral cutter blade (10 pcs.)
- Torque wrench 6 Nm
- PU-tube diam. 100 mm (6 m)
- Dust collector DC 230 E / 230 V with tube (2,5 m)
- Digital angle finder
- Universal mobile base UFW 300

Art. no.	excl. VAT
15-1078	
15-1079	
15-1080	
12-1077	
12-2043	
31-1044	
56-10705	

# Thicknesser

# TH 330 TH 330 S

The TH 330 / TH 330 S is a compact and easily transported planer and thicknesser, making this model ideal for use on construction sites. The planer unit - guided on four threads - and the rubber coated in- and outfeed roller for safe workpiece feed, guarantees the most accurate planing results.

- Reduction of noise level (approx. 50%) due to the standard spiral cutter head and up to 20 times the cutting edge life (results from four-way carbide inserts) (TH 330 S)
- Advantage of the carbide inserts: If damaged, individual knives can be exchanged or turned (TH 330 S)
- The carbide blades ensure tear-free planing results and optimal surfaces with any type of wood (TH 330 S)
- Handwheel and scale allow for precise adjustment of chip removal
- Rubber-coated in- and outfeed roller for consistent workpiece feed and quality finish
- Foldable table extensions keep required space to a minimum
- Optimal for planing of boards, beams and planks
- Includes dust hood at the back of machine
- Handles on the side allow for easy transportation
- Precisely bedded 2-knife cutterblock with HSS cutter knives
- Planing unit is guided fourfold to guarantee precise results
- Automatic workpiece infeed (8 m/mm)

**Best  
price**



#### Optional accessories:

Set of planer knives in HSS-quality (2 pcs.)	Art. no.	excl. VAT
TCT-blades for spiral cutter (10 pcs.)	15-1068	
Spare screws of spiral cutter blade (10 pcs.)	15-1078	
Torque wrench 6 Nm	15-1079	
PU-tube diam. 100 mm (6 m)	15-1080	
Suction canister BDC 1200	12-1077	
	12-1996	

Technical data	TH 330	TH 330 S
Working width	330 mm	330 mm
Working height min./max.	5 - 150 mm	5 - 155 mm
Table size with extension	640 x 330 mm	640 x 330 mm
Max. cutting depth	2,8 mm	2,8 mm
Working length min.	140 mm	140 mm
Planer shaft diameter	50 mm	50 mm
Cutter knives	2 pcs.	-
TCT-blades	-	30 pcs.
Shaft rotation speed	9500 rpm	9500 rpm
Feed speed	8 m/min	8 m/min
Dust extraction outlet	50 / 100 mm	50 / 100 mm
Motor power output S <sub>1</sub> 100%	1,5 kW (2,0 HP)	1,5 kW (2,0 HP)
Motor power input S <sub>6</sub> 40%	2,1 kW (2,8 HP)	2,1 kW (2,8 HP)
Voltage	230 V	230 V
Machine dimension (L x W x H)	550 x 650 x 490 mm	550 x 640 x 475 mm
Weight approx.	33 kg	30 kg
Art. no.	08-1012	08-10120



The solid planing unit features a precisely bedded spiral cutter head to guarantee best results (TH 330 S).

#### Standard accessories:

- Cutter knives in HSS-quality (TH 330)
- Spiral cutter head with 30 pcs. TCT-blades (TH 330 S)
- Replacement TCT-blades (5 pcs.) (TH 330 S)
- Foldable table extensions with rolls

# Thickener

# DH 310

The DH 310 thickening machine was developed with a focus on safety, stability, compact construction and user-friendliness. Furthermore this model features a digital display for precise thickening table adjustment.

- Precisely bedded, smooth running 4-knife cutterblock guarantees optimal results
- Thickening table with central column and support allow precise planing
- Digital display on handwheel features 1/10 mm scaling for precise adjustment of thickening table
- Noise-reducing cutterblock cover keeps noise levels down
- Ground thickening table for workpieces up to 230 mm in height
- Serially with table extension with integrated rolls
- Chain drive allows safe and consistent workpiece infeed
- Large anti-kickback devices eliminate ejection of workpieces
- Several safety devices: On/Off switch with undervoltage release, limit switch to avoid accidental machine start, emergency-stop switch



The precisely bedded 4-knife cutterblock and the straight-toothed of the infeed roller ensure top work results.



Solid thickening table with spindle guide and support for accurate planing of board, slats, planks etc.



The chain drive ensures consistency of infeed and outfeed rollers.



Tables can be adjusted precisely - 1/10 mm - using the digital display.



Technical data	DH 310
Working width	310 mm
Working height min./max.	5 - 230 mm
Table size	930* x 310 mm
Max. cutting depth	5 mm
Working length min.	150 mm
Planer shaft diameter	95 mm
Cutter knives	4 pcs.
Shaft rotation speed	4050 rpm
Feed speed	6 m/min
Dust extraction outlet	100 mm
Motor power output S <sub>1</sub> 100%	3,0 kW (4,0 HP)
Motor power input S <sub>6</sub> 40%	4,2 kW (5,7 HP)
Voltage	400 V
Machine dimension (W x D x H)	1110 x 600 x 1020 mm
Weight approx.	180 kg
Art. no.	08-1094

\* with table extension

#### Standard accessories:

- Cutter knives in HSS-quality
- Knife gauge
- Digital indication for thickening table adjustment
- Table extension with rolls

#### Optional accessories:

- Cutter knives 310 x 30 x 3 mm, price per pc.
- Spiral cutter head with 52 pcs. TCT-blades
- TCT-blades for spiral cutter (10 pcs.)
- Dust collector DC 400 / 400 V
- Dust collector DC 500 E / 400 V
- PU-tube diam. 100 mm (6 m)
- Universal mobile base UFW 300
- Automatic start-up ALV 10 / 1 M
- Lubricant 1 kg, paste

**BERNARDO**  
www.bernardo.at  
**SEMIPROFESSIONAL**

Art. no.	excl. VAT
15-1005	
15-10812	
15-1078	
12-2060	
12-2066	
12-1077	
56-10705	
12-1150	
54-1000	

# Thickener with spiral cutter head

# DH 310 S

- Reduction of noise level (approx. 50%) due to the standard spiral cutter head and up to 20 times the cutting edge life (results from four-way carbide inserts)
- Advantage of the carbide inserts: If damaged, individual knives can be exchanged or turned
- Thickening table with central column and support allow precise planing
- The carbide blades ensure tear-free planing results and optimal surfaces with any type of wood
- Ground thickening table for workpieces up to 230 mm in height
- Serially with table extension with integrated rolls
- Chain drive allows safe and consistent workpiece infeed
- Several safety devices: On/Off switch with undervoltage release, limit switch to avoid accidental machine start, emergency-stop switch



The precisely bedded spiral cutter head and the straight toothed of the infeed roller ensure top work results.



Solid thickening table with spindle guide and support for accurate planing of board, slats, planks etc.



The chain drive ensures consistency of infeed and outfeed rollers.



Tables can be adjusted precisely - 1/10 mm - using the digital display.



**BERNARDO**  
www.bernardo.at  
**SEMIPROFESSIONAL**

#### Standard accessories:

- Spiral cutter head with 52 pcs. TCT-blades
- Replacement TCT-blades (5 pcs.)
- Digital indication for thickening table adjustment
- Table extension with rolls

#### Optional accessories:

	Art. no.	excl. VAT
TCT-blades for spiral cutter (10 pcs.)	15-1078	
Spare screws of spiral cutter blade (10 pcs.)	15-1079	
Torque wrench 6 Nm	15-1080	
Dust collector DC 400 / 400 V	12-2060	
Dust collector DC 500 E / 400 V	12-2066	
PU-tube diam. 100 mm (6 m)	12-1077	
Universal mobile base UFW 300	56-10705	
Automatic start-up ALV 10 / 1 M	12-1150	
Lubricant 1 kg, paste	54-1000	

#### Technical data

#### DH 310 S

Working width	310 mm
Working height min./max.	5 - 230 mm
Table size	930* x 310 mm
Max. cutting depth	5 mm
Working length min.	150 mm
Planer shaft diameter	95 mm
TCT-blades	52 pcs.
Shaft rotation speed	4050 rpm
Feed speed	6 m/min
Dust extraction outlet	100 mm
Motor power output S <sub>1</sub> 100%	3,0 kW (4,0 HP)
Motor power input S <sub>6</sub> 40%	4,2 kW (5,7 HP)
Voltage	400 V
Machine dimension (W x D x H)	1110 x 600 x 1020 mm
Weight approx.	180 kg
Art. no.	08-1096

\* with table extension

# Thicknesser

# DH 410

The DH 410 thickening machine was developed with a focus on safety, stability, compact construction and user-friendliness. Furthermore this model features a digital display for precise thickening table adjustment.

- Precisely bedded, smooth running 4-knife cutterblock guarantees optimal results
- Thickening table with central column and support allow precise planing
- Digital display on handwheel features 1/10 mm scaling for precise adjustment of thickening table
- Noise-reducing cutterblock cover keeps noise levels down
- Ground thickening table for workpieces up to 230 mm in height
- Serially with table extension with integrated rolls
- Chain drive allows safe and consistent workpiece infeed
- Large anti-kickback devices eliminate ejection of workpieces
- Several safety devices: On/Off switch with undervoltage release, limit switch to avoid accidental machine start, emergency-stop switch



The precisely bedded 4-knife cutterblock and the straight-toothed of the infeed roller ensure top work results.

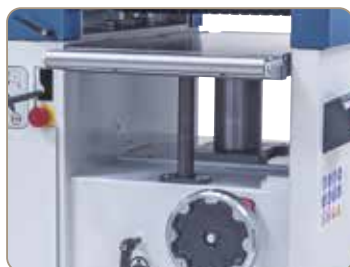

Solid thickening table with spindle guide and support for accurate planing of board, slats, planks etc.



The chain drive ensures consistency of infeed and outfeed rollers.



Tables can be adjusted precisely - 1/10 mm - using the digital display.



Technical data	DH 410
Working width	410 mm
Working height min./max.	5 - 230 mm
Table size	930* x 410 mm
Max. cutting depth	5 mm
Working length min.	150 mm
Planer shaft diameter	95 mm
Cutter knives	4 pcs.
Shaft rotation speed	4050 rpm
Feed speed, stepless	6 m/min
Dust extraction outlet	100 mm
Motor power output S <sub>1</sub> 100%	3,0 kW (4,0 HP)
Motor power input S <sub>6</sub> 40%	4,2 kW (5,7 HP)
Voltage	400 V
Machine dimension (W x D x H)	1110 x 710 x 1020 mm
Weight approx.	239 kg
Art. no.	08-1107

\* with table extension

#### Standard accessories:

- Cutter knives in HSS-quality
- Knife gauge
- Digital indication for thickening table adjustment
- Table extension with rolls

#### Optional accessories:

- Cutter knives 410 x 30 x 3 mm, price per pc.
- Spiral cutter head with 72 pcs. TCT-blades
- TCT-blades for spiral cutter (10 pcs.)
- Dust collector DC 400 / 230 V
- Dust collector DC 500 E / 400 V
- PU-tube diam. 100 mm (6 m)
- Universal mobile base UFW 300
- Automatic start-up ALV 10 / 1 M
- Lubricant 1 kg, paste

Art. no.	excl. VAT
15-1016	
15-10811	
15-1078	
12-2055	
12-2066	
12-1077	
56-10705	
12-1150	
54-1000	

**BERNARDO**  
SEMIPROFESSIONAL

# Thicknesser

# TP 410 N

The TP 410 N thicknesser is serially equipped with a stepless variator gearbox, allowing to adjust the infeed speed to the workpiece. Furthermore this model features a digital display for precise thickening table adjustment.

- Variator gearbox allows stepless infeed speed adjustment from 5 - 7 m/min
- Digital display with an accuracy of 1/10 mm on the handwheel for precise adjustment of thickening table
- Ground thickening table, height adjustment by handwheel
- Table with central column and support to guarantees most accurate results
- Chain drive allows safe and consistent workpiece infeed
- Solid cutterblock for precise results
- Power switch includes undervoltage release

**BERNARDO**  
www.bernardo.at  
**SEMI PROFESSIONAL**



Ground thickening table for workpieces up to 225 mm in height. The set height can be read on the digital indication.



The torsion-free thickening table is guided on a central column with support.



The infeed is driven by a solid chain drive. The infeed speed is 5 - 7 m/min.



The planing unit features a 70 mm cutterblock to guarantees most accurate results.



**Digital readout for thickening table adjustment**

**Variable feeding speed**

## Technische Daten

## TP 410 N

Working width	406 mm
Working height min./max.	5 - 225 mm
Table size	600 x 406 mm
Max. cutting depth	4 mm
Working length min.	125 mm
Planer shaft diameter	70 mm
Cutter knives	3 pcs.
Shaft rotation speed	5500 rpm
Feed speed, stepless	5 - 7 m/min
Dust extraction outlet	100 mm
Motor power output S <sub>1</sub> 100%	3,0 KW (4,0 HP)
Motor power input S <sub>6</sub> 40%	4,2 kW (5,7 HP)
Voltage	400 V
Machine dimension (W x D x H)	750 x 680 x 1005 mm
Weight approx.	160 kg
Art. no.	08-1104

## Standard accessories:

- Cutter knives in HSS-quality
- Knife gauge
- Digital indication for thickening table adjustment
- Stepless infeed

## Optional accessories:

Cutter knives 410 x 25 x 3 mm, price per pc.	Art. no.	excl. VAT
Planer knives adjustment HML	15-1017	
Dust collector DC 500 E / 400 V	08-1500	
PU-tube diam. 100 mm (6 m)	12-2066	
Universal mobile base UFW 300	12-1077	
Lubricant 1 kg, paste	56-10705	
Automatic start-up ALV 10 / 1 M	54-1000	
	12-1150	

# Thickener with spiral cutter head

# DH 410 S

- Reduction of noise level (approx. 50%) due to the standard spiral cutter head and up to 20 times the cutting edge life (results from four-way carbide inserts)
- Advantage of the carbide inserts: If damaged, individual knives can be exchanged or turned
- Thickening table with central column and support allow precise planing
- The carbide blades ensure tear-free planing results and optimal surfaces with any type of wood
- Ground thickening table for workpieces up to 230 mm in height
- Serially with table extension with integrated rolls
- Chain drive allows safe and consistent workpiece infeed
- Several safety devices: On/Off switch with undervoltage release, limit switch to avoid accidental machine start, emergency-stop switch



The precisely bedded spiral cutter head and the straight toothed of the infeed roller ensure top work results.



Solid thickening table with spindle guide and support for accurate planing of board, slats, planks etc.



The chain drive ensures consistency of infeed and outfeed rollers.



Tables can be adjusted precisely - 1/10 mm - using the digital display.



**BERNARDO**  
www.bernardo.at  
**SEMIPROFESSIONAL**

Technical data	DH 410 S
Working width	410 mm
Working height min./max.	5 - 230 mm
Table size	930* x 410 mm
Max. cutting depth	5 mm
Working length min.	150 mm
Planer shaft diameter	95 mm
TCT-blades	72 pcs.
Shaft rotation speed	4050 rpm
Feed speed, stepless	6 m/min
Dust extraction outlet	100 mm
Motor power output S <sub>1</sub> 100%	3,0 kW (4,0 HP)
Motor power input S <sub>6</sub> 40%	4,2 kW (5,7 HP)
Voltage	400 V
Machine dimension (W x D x H)	1110 x 710 x 1020 mm
Weight approx.	239 kg
Art. no.	08-1108

\* with table extension

#### Standard accessories:

- Spiral cutter head with 72 pcs. TCT-blades
- Replacement TCT-blades (5 pcs.)
- Digital indication for thickening table adjustment
- Table extension with rolls

#### Optional accessories:

	Art. no.	excl. VAT
TCT-blades for spiral cutter (10 pcs.)	15-1078	
Spare screws of spiral cutter blade (10 pcs.)	15-1079	
Torque wrench 6 Nm	15-1080	
Dust collector DC 400 / 230 V	12-2055	
Dust collector DC 500 E / 400 V	12-2066	
PU-tube diam. 100 mm (6 m)	12-1077	
Universal mobile base UFW 300	56-10705	
Automatic start-up ALV 10 / 1 M	12-1150	
Lubricant 1 kg, paste	54-1000	

# Thicknesser

# TP 630 D

- Ergonomically arranged switches and control elements on the front of the machine
- Solid thickening table serially equipped with two driven infeed rollers
- Stepless infeed speed adjustment 5 - 18 m/min
- Torsion-free, grey cast iron construction assures a smooth run
- Thickening table adjustment features digital display with 1/10 mm accuracy
- Quick and easy motorized height adjustment of thickening table
- Serially equipped with 2 dust extractor outlets Ø 150 mm
- Adjustable thickening table rollers allow planing of wet or rough wood
- Noise-absorbing cutterblock cover minimizes noise
- Large anti-kickback devices eliminate kickback of workpieces



To assure consistent workpiece infeed, the thickening table features two precisely adjustable rollers.



The solid planing unit features a precisely bedded 4-knife cutterblock to guarantee accurate results, even during heavy workload.



The chain drive ensures consistency of infeed and outfeed rollers.



The solid, grey cast iron thickening table features a motorized height adjustment 4 - 300 mm. The height adjustment takes place by four large guide arbors, the guideway with four precision flat guidings is designed for heavy workload.



Segmented infeed roller and pressure bar allow simultaneous planing of workpieces with different thicknesses.



For accurate planing results, the feed speed of the infeed and outfeed roller can be adjusted to the workpiece using the frequency converter.

## Technical data

## TP 630 D

Working width	630 mm
Working height min./max.	4 - 300 mm
Table size	1200 x 630 mm
Thickening rollers	2 pcs.
Max. cutting depth	10 mm
Workpiece length min.	300 mm
Planer shaft diameter	120 mm
Cutter knives	4 pcs.
Shaft rotation speed	5000 rpm
Feed speed, stepless	5 - 18 m/min
Dust extraction outlet	2 x 150 mm
Motor power output S: 100%	7,5 kW (10,0 HP)
Feeding motor	1,5 kW (2,0 HP)
Elevating motor	0,37 kW (0,50 HP)
Machine dimension (W x D x H)	1150 x 1240 x 1500 mm
Weight approx.	1250 kg
Art. no.	08-1126

The TP 630 D thickening machine was developed with a focus on safety, stability, compact construction and user-friendliness. The large variety of standard accessories make this model excellent in price-performance ratio.

# TP 630 D



The ergonomically arranged switches and control elements, features a digital display for the thickening table adjustment.

Electronic thickening table positioning



Serially with electronic thickening table positioning by keypad and digital readout.



Thickener rollers serially

Segmented infeed roller

### Standard accessories:

- Cutter knives in HSS-quality
- 1 driven thickening table roller
- Segmented infeed roller
- Digital display for thickening table adjustment
- Thickening table clamping
- 2 dust extractor outlets Ø 150 mm
- Stepless infeed speed
- Thickening table guided on 4 guide bars
- Motorized table height adjustment

Stepless feeding speed

**BERNARDO**<sup>®</sup>  
www.bernardo.at  
**PROFESSIONAL**

**BERNARDO**<sup>®</sup>  
www.bernardo.at

notes

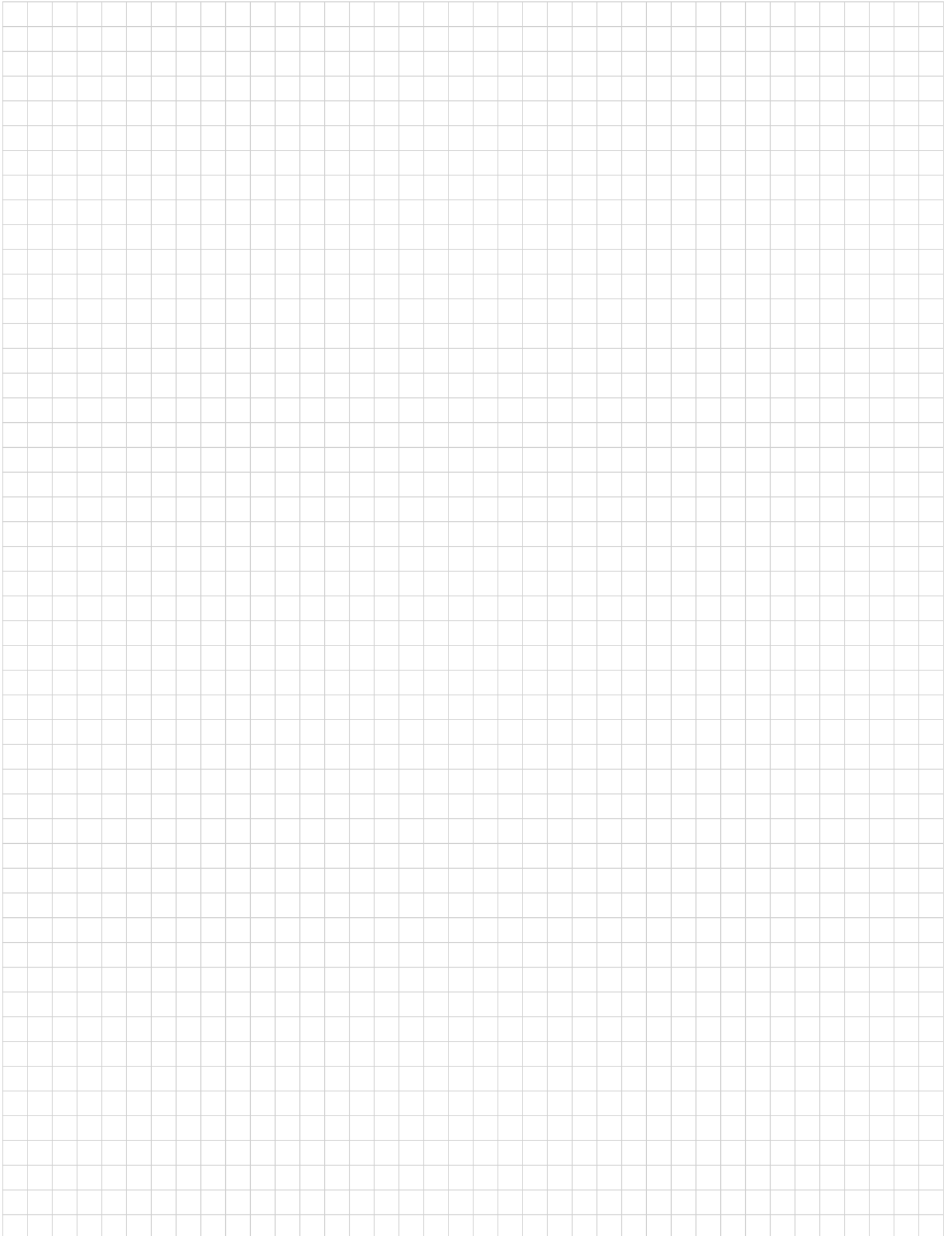

notes

A large grid of graph paper for taking notes, consisting of 20 columns and 30 rows of small squares.

**Imprint:**

All rights reserved – reproduction of images or texts or parts of these is strictly prohibited unless prior arrangements are made. Subject to technical and optical amendments. Product specifications subject to change without notice. Not responsible for printing errors or mistakes. Machines are partly displayed with optional extras. Prices subject to change. Prices in Euros, ex works (Linz, Austria), excl. any taxes. Edition 05/2025.

Your dealer

**BERNARDO**<sup>®</sup>  
www.bernardo.at

**PWA Handelsges.m.b.H.**  
4020 Linz | Nebingerstraße 7a | Austria  
phone: +43.732.66 40 15 | fax: +43.732.66 40 15-9  
e-mail: bernardo@pwa.at | www.bernardo.at